



RÖCHLING



**High performance plastics
for the chemical processing
industry**



Chemical processing industry



Content

Areas of application	4
Tanks for storing liquids	
Galvanic plants	
Steel-pickling plants	
Water-treatment plants	
Exhaust-air cleaning plants	
Ventilation plants	
Materials	10
PE-HD	
PP	
PVC	
PVDF	
E-CTFE	
Polystone® P CubX®	
Polystone® Safe-Tec C	
Foamlite®	
Polystone® P flex grey	
Full service for tank construction	26
Welding rods	
U-profiles and square tubes	
RITA® 4	
Chemical resistance	30
Weather resistance	34
Electrical conductivity	34
Fire behaviour	35
Quality assurance	36
Our offer at a glance	39

Competence in plastics

With sales of € 1.8 billion and 10,000 employees at 90 locations in 25 countries, the global Röchling Group stands for competence in plastics. We leverage the unique innovation potential of this material – from semi-finished products right through to complex systems.

Röchling Industrial

The Industrial Division serves almost all sectors of industry with application-oriented optimal materials. To do so Röchling has the most comprehensive product portfolio of thermoplastics and composites worldwide. Semi-finished products such as sheets, rods, tubes, flat bars, castings as well as profiles and machined and assembled precision components are manufactured.

www.roechling.com

High performance plastics for the chemical processing industry

Thermoplastics have been implemented in the chemical industry as a material for tanks and plants for many decades now. Ranking amongst the most important fields of activity are:

- Tanks for storing liquids
- Galvanic plants
- Steel-pickling plants
- Water-treatment plants
- Exhaust-air cleaning plants
- Ventilation plants

The great benefit of thermoplastics in many of these applications is the high chemical and corrosion resistance. Depending on the mechanical requirements, plant parts can be produced in all-thermoplastic or alternatively in composite material with a glassfibre reinforced plastic (FRP) or steel as supporting material.

The plastics from Röchling Industrial have proven themselves in the above-mentioned fields of application over decades on end. They are characterised by outstanding chemical resistance, can be easily processed, and meet the requirements of current guidelines and standards for the construction of chemical tanks and plants.

Complete system

Röchling Industrial has one of the largest product ranges for chemical-tank and plant construction.

We offer a complete system for your application – comprising sheet material, U and square profiles as well as welding rods right up to the time-tested RITA® 4 tank calculation programme, as well as expert consultation in selecting the right material.

Furthermore, Röchling disposes of comprehensive databases and long years of experience pertaining to the chemical resistance of thermoplastics.

This prospectus will give you an overview of our competence for the construction of chemical tanks and plants.



Tanks for storing liquids

For application in tanks for storing liquids in chemical-tank and plant construction, plastics must fulfill varying demands: Included here is resistance to thermal and chemical corrosion as well as static loading and – depending on the set-up – resistance to weathering influences. Röchling's wide product range offers just the right solution for practically any application.

Tank variants

Round tanks are mainly used for storing liquids. Round tanks can be made of sheet material, in a strip winding process or as composite tanks. In all three cases, plastics from Röchling are used, either for the tank as a whole, in the stripe winding process, for the cover and base, or as liners in composite tanks. The production of **rectangular tanks** is comparatively more elaborate and thus more expensive, since, in most cases of rectangular tanks, steel reinforcements must be resorted to support the side walls and base.

Moulding compounds with DIBt approval

In its engineering and testing principles for water-pollution control, the German Institute for Civil Engineering (DIBt) stipulates that for above-ground tanks and tank parts made of thermoplastics that are used for storing water-hazardous liquids, only sheets may be put to use which are manufactured of moulding compounds approved by the building authorities. For this very reason, Röchling only uses moulding compounds listed by the DIBt to produce sheets and welding rods of the tank construction type

Polystone® G black B 100

Polystone® G black B 100-RC as well as

Polystone® G blue B 100-RC.

UV resistance

Due to the fact that storage tanks are mainly not set up inside buildings, but outside, UV resistance of the material used is also a requirement. The most effective way to protect materials, such as PE and PP, against UV damage is adding carbon black. This is why many tanks for outside storage of liquids are black.



Galvanic plants

In galvanic plants, items are provided with a metallic coating in an electrochemical process in order to increase their corrosion resistance. Metals that are typically applied here are nickel and copper. Also falling under the category of galvano technique or electroplating are such processes as chrome-plating machine parts, zinc-coating nuts and bolts as well as anodic oxidation of aluminium parts (anodisation).

Due to the diversity of these chemical processes, various plastics from Röchling are used in galvanic plants. Depending on the kind of application concerned, the plastics must feature a high temperature and chemical resistance.

This is why it is an absolute must to precisely clarify the resistance of the selected plastic material to the chemicals to be used at the working temperature specified. Röchling's wide product range offers just the right solution for practically any application.



Polystone® P homopolymer grey
Tank for a copper-coating plant



Polystone® P homopolymer grey
Galvanic line



Chromic acid tanks made from
Polystone® PVDF FM



Tanks made from **Polystone® P**
in a plastic electroplating plant



**Polystone® P homopolymer grey and
Polystone® P homopolymer natural**
Drums for a galvanic plant



Polystone® P homopolymer natural
Anodisation basin for treating door handles



Polystone® P homopolymer grey
Galvanic plant for the treatment of aluminium parts

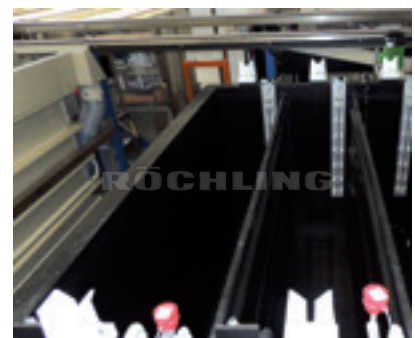

Tanks made from **Polystone® G HD black**
in an electroplating plant

Steel-pickling plants

In the pickling process, cold-rolled steel bands are rid of the scaling incurred on the surface by the hot-rolling process. In the last two decades, application of polypropylenes in pickling tanks has been timetested and is ever increasingly substituting rubberised or brick lined steel tanks.

Typical process conditions in steel-pickling plants are:

- Medium: HCl 10 – 20%
temperature: 80 °C – 90 °C
- Medium: H₂SO₄ 50%
temperature: bis 105 °C

Typical process conditions in stainless steel-pickling plants are:

- Medium: HF 10% + HNO₃ 18%
temperature: 50 °C – 65 °C

Due to these varying requirements, different polypropylene types are used. Differentiation is made between PP-H (polypropylene homopolymer), PP-R (polypropylene random-copolymer) and PP-B (polypropylene block-copolymer). By reason of the high process temperatures, application of PP-H is preferred in steel-pickling plants, depending on the maximum temperature with an additional heat stabilisation as **Polystone® P homopolymer EHS** (Extra Heat Stabilised).

With medium mixtures causing stress cracks such as HF-HNO₃, Röchling recommends the application of the softer PP-R. Softer thermoplastic material types can absorb the incurred stress more easily without stress cracks being thus caused. Should it be intended to transport the plants at temperatures below 5 °C, PP-B offers great benefits over PP-H due to its high notched impact resistance, and it possesses toughness even at -30 °C, while PP-H becomes brittle at temperatures below 0 °C, whereby damage to the plant may easily be incurred during transport. PP-R still has good notched impact resistance at temperatures down to -20 °C as well.

There is only slight differentiation to be made between the three PP variants in their chemical resistance. With the copolymers, diffusion rates are somewhat higher than with PP-H. Since 30 to 40 mm thick sheets are mostly used for the tank walls for steel-pickling plants, diffusion plays here, however, only a subordinate role.



Polystone® P Random-Copolymer grey
Tank for a steel-pickling plant



Polystone® P random-copolymer grey
Mixed acid pickling tank



Polystone® P homopolymer grey
Extra heat stabilised for a steel-pickling plant

Water-treatment plants

Water treatment has great importance for the quality of life of people throughout the world. About two million people die as a consequence of impure water every year, and on the global scale about two billion do not have adequate access to clean water.

The plastics used in water treatment must have a high degree of purity for contact with drinking water and be particularly chemical-resistant. Röchling offers one of the biggest product ranges for water treatment: The plastics used have good chemical resistance, possess the high purity required and fulfill the current standards and directives, as well as have the necessary approvals available.

Typical fields of application include:

- Well construction
- Desalination plants
- Drinking-water tanks and linings
- Neutralisation plants
- Chemical water treatment
- Sewage purification plant construction



Polystone® G HD blue
Lining of a drinking water reservoir

Drinking water approvals

	KTW	W270	ACS
Polystone® G HD blue	+	+	
Polystone® G black B 100	+		+
Polystone® P homopolymer grey	+		

In addition to **Polystone® G HD blue** and **Polystone® G black B 100**, **Polystone® P** materials can also be supplied that meet the physical/chemical requirements of the KTW assessment basis.



Polystone® G black B 100
Back-flushing unit



Polystone® G black B 100
Tanks in a sewage plant



Polystone® P copolymer grey
Process tanks for wastewater treatment



Exhaust-air cleaning plants

In order to minimise damage to health and the environment through air-borne pollutants, there are different regulations and directives in many countries to restrict the pollutant loads in emissions. This frequently makes waste-air purification necessary.

Typical plants for waste-air purification are droplet separators and gas scrubbers:

In **droplet separators**, upward exhaust air is conducted into tanks through incorporated components. Here, the toxic substances are deposited onto these fittings as droplets and collect in the lower part of the tank.

In **gas scrubbers**, the exhaust air is cleaned through a liquid supplied whereby the toxic substances collect in the liquid. Liquids typically used here are suspensions such as milk of lime. The liquids and gases used for cleaning or the exhaust air to be purified, such as SO_2 and SO_3 in flue-gas desulphurisation plants, are often severely corrosive. Thermoplastics are implemented because of their special corrosion resistance.



Polystone® G black B 100 Air purification system in a water treatment plant



Polystone® G black B 100 Exhaust air scrubbers of a domestic waste sorting plant



Gas scrubbers in a biogas plant made from Polystone® P homopolymer grey



Gas scrubber made of Polystone® P homopolymer grey



Bio filters for odor neutralisation

Ventilation plants

Removal of polluted air is an important challenge in buildings and chemical plants. Both ventilator construction as well as provision of air ventilation ducts and housings for plant parts are included in the field of ventilation plants.

Röchling's plastics are also used here on the basis of their good chemical resistance and outstanding processing properties. **Polystone® PVDF FM** is frequently implemented here as an inliner for ducts made of glass-fibre-reinforced plastics. Should the static, thermal and chemical load permit, complete plants are made of PE, PP or PVC.

Often, special requirements are also made on the materials used in ventilation plants with regard to electrical conductivity and low inflammability. **Polystone® PPs** is a low-inflammable polypropylene employed very frequently for ventilation plants. If electrical conductivity of the materials is additionally required, Röchling recommends application of **Polystone® PPs EL black**.

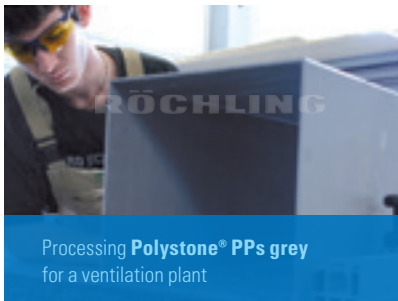

Processing **Polystone® PPs grey** for a ventilation plant



Polystone® G HD black
Housing of a ventilation plant



Polystone® P homopolymer grey
Ventilation system for a galvanic plant



Trovidur® EC-N and
Polystone® PVDF FM Ventilation plant



Ducting system made from **Polystone® PPs grey**

Polyethylene (PE-HD)

Polyethylene has a simple molecular structure. CH₂ segments are lined up in a simple form. Depending on the polymerization process however, polyethylene can be manufactured with different densities. The different densities result from the number of cross branches between the main molecular chains. Further, the greater the number and length of the branches between these chains the lower the crystallinity of the resulting material, and therefore, the lower the density.

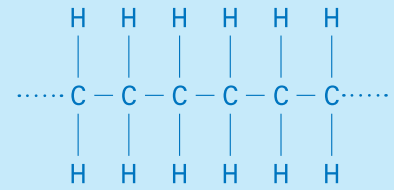

Molecular structure of polyethylene

Polyethylene has the following typical properties:

- Low density
- High strength
- High elongation at break
- Application temperature range from -50 °C to +90 °C
- Good electrical insulation properties
- Very good chemical resistance
- Very low water absorption

The physical properties of PE are greatly dependent on the length of the molecular chains (molecular weight) and the structure of the molecules (crystallinity). As stated, the degree of branching between the molecular chains and the length of the side chains significantly influence the level of crystallinity and density of the polyethylene. An example of the effects of these differences in terms of physical properties can be seen by comparing PE-HD and PE-LD. PE-HD is produced when the polymerization occurs under low pressure allowing longer and less branched molecular chains to form, along with an increase crystallinity. This

results in a relatively high elastic modulus and hardness. The situation is exactly the reverse in the case of PE-LD. Consequently PE-LD has a lower crystallinity leading to a lower elastic modulus, hardness and ultimate strength than PE-HD. Additional to the higher crystallinity, PE-HD for chemical applications has normally a higher molecular weight than PE-LD. This higher molecular weight results in more knots and eyes between the molecules. These formations hold the structure of the material even stronger together increasing its toughness. In general the viscosity and the density of PE is measured in order to assess what type of polyethylene has been produced.

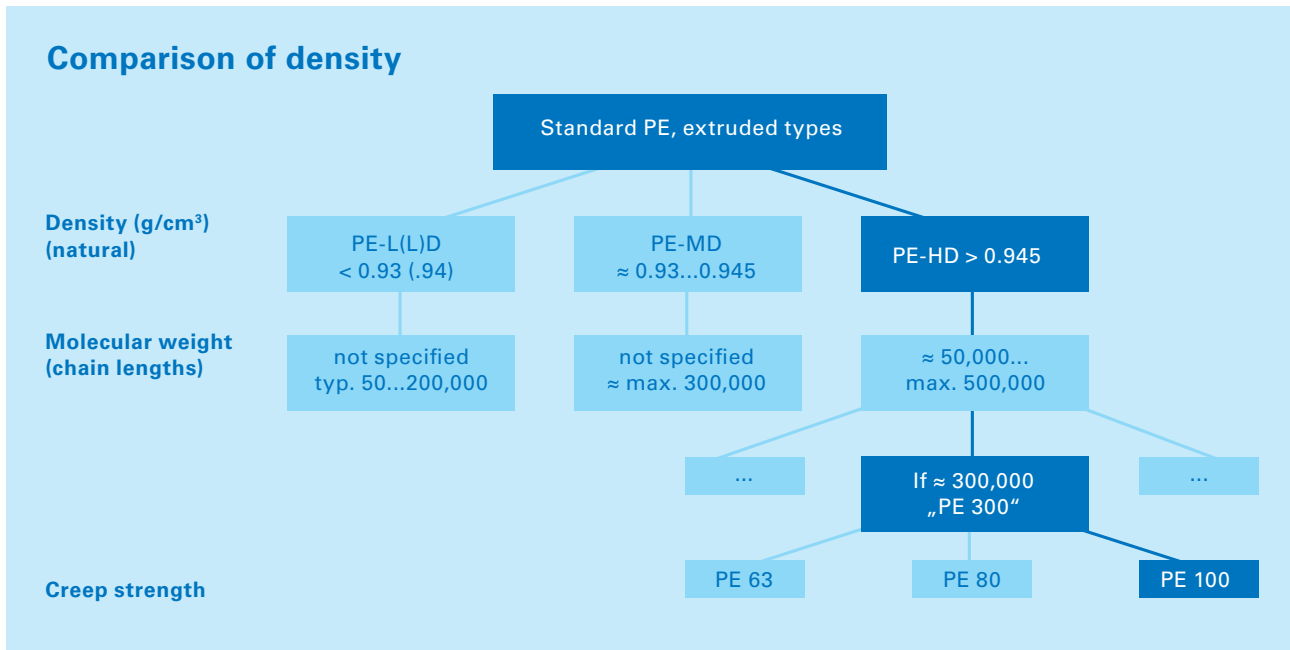

Types PE 80 and PE 100 used as standard in chemical tank and plant construction today belong to the Group PE 300 (PE-HD), the figures 80 and 100 referring to the MRS Class. MRS stands for Minimum Required Strength and describes the minimum strength which a material must still possess in the long-term failure test under internal hydrostatic pressure at 20 °C after 50 years. A PE-HD will therefore be rated in the MRS Class PE 80 if the strength lies over 8 N/mm². If it is higher than 10, the material fulfils the requirements of a PE 100.

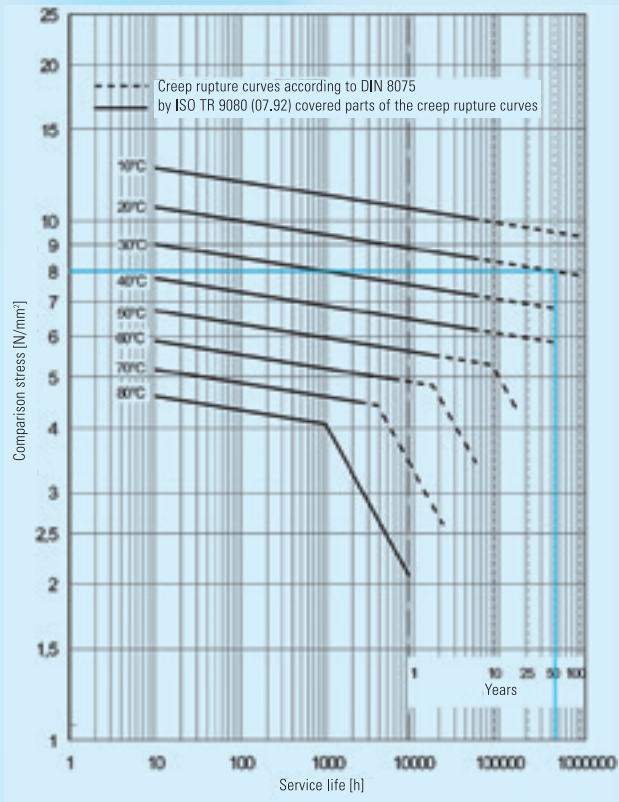

Requirements made on a PE 80 shown by means of the creep-strength curves of DVS 2205, Part 1. A PE 80 should retain a minimum strength of 8 N/mm² at a working temperature of 20 °C over a service life of 50 years.

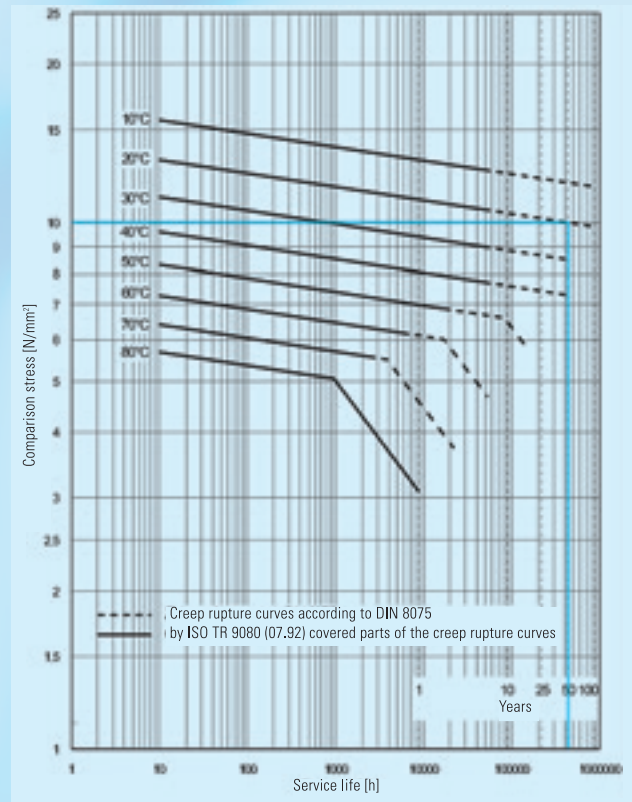

Requirements made on a PE 100 shown by means of the creep-strength curves of DVS 2205, Part 1. A PE 100 should retain a minimum strength of 10 N/mm² at a working temperature of 20 °C over a service life of 50 years.



The raw materials for Polystone® G black B 100 used by Röchling are listed at the DIBt (German Institute for Civil Engineering), thus meeting the requirements defined by the DIBt for application in tank construction.

Polyethylene (PE-HD)

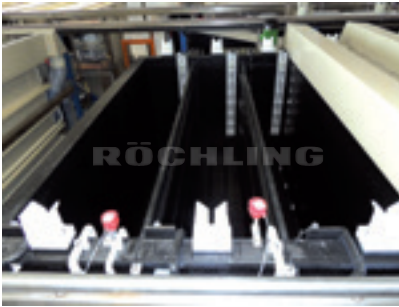

Tanks made from **Polystone G HD black** in an electroplating plant

Polystone® G HD black

Polystone® G HD black is high-density polyethylene. The material is characterised by a high chemical resistance and easy processing. Particularly the high chemical resistance makes **Polystone® G HD black** ideal for the use in the chemical processing industry.

Properties

- Good chemical resistance
- Good UV resistance
- High resistance against stress cracking



Polystone® G black B 100
Air purification system in a water treatment plant

Polystone® G black B 100

For the production of **Polystone® G black B 100** only raw materials are used which are approved for tank building. The demands of the pipe grade PE 100 (MRS class) are met and are regularly monitored by third parties.

Properties

- Excellent weldability and processing properties
- High elongation at break, very suitable for tank building
- Very good chemical resistance
- Approved in Germany for tanks requiring mandatory test certificates according to § 63 WHG
- High resistance against stress cracking (FNCT > 300 h)
- Suitable for contact with drinking water (tested according to W270, ACS and the physical/chemical requirements of the KTW evaluation basis)



Polystone® G black B 100-RC
Storage tanks for hydrochloric acid

Polystone® G black B 100-RC

Polystone® G black B 100-RC is a PE 100 with significant higher stress cracking resistance. Only raw materials are used which are approved for tank building.

Properties

- High elongation at break, very suitable for tank building
- Good chemical resistance
- Approved in Germany for tanks requiring mandatory test certificates according to § 63 WHG
- High resistance against stress cracking (FNCT > 8760 h)



Polystone® G HD blue
Domestic sewage system

Polystone® G HD blue

Polystone® G HD blue is ideal for applications in the drinking-water sector because of its colour being similar to RAL 5015.

Properties

- BfR approval
- Corresponds to the physical/chemical requirements of the KTW evaluation basis
- W270 approval
- Suitable for contact with drinking water
- Good chemical resistance



Polystone® G blue B 100-RC
Storage tank with collecting tank

Polystone® G blue B 100-RC

Polystone® G blue B 100-RC is a PE 100 with significant higher stress cracking resistance. Only raw materials are used which are approved for tank building.

Properties

- High elongation at break, very suitable for tank building
- Good chemical resistance
- Approved in Germany for tanks requiring mandatory test certificates according to § 63 WHG
- High resistance against stress cracking (FNCT > 8760 h)



Polystone® G EL black
Scrubber

Polystone® G EL black

Polystone® G EL black is a very highly conductive PE-HD material offering excellent long-term mechanical properties.

Properties

- Electrically conductive
- UV resistant
- Easy processing
- Excellent weldability
- Good chemical resistance
- Almost no moisture absorption
- Excellent mechanical properties



Polystone® G HD SK black
FRP lined tank for desalinated water

Polystone® G HD SK/GK black

Polystone® G HD SK/GK black sheets are coated on one side to enable bonding to other materials. The material used is either a polyester stretch (SK) or, in the case of strongly diffusing chemicals and/or high temperature fluctuations, knitted glass fibre (GK). **Polystone G® HD/GK black** offers especially high strength when bonded and in composite construction.

Properties

- Excellent weldability and processing properties
- High adhesion in a composite system and so highly suitable for tank building
- Good chemical resistance

Polypropylene (PP)

The polypropylene is produced through the polymerization of propylene. A laterally added methyl group (CH₃ group) can be arranged differently in space. This results in PP products with different properties, enabling polypropylene to be differentiated on the basis of the following characteristics:

Isotactic polypropylene: With this polypropylene, all CH₃ groups are on the same side.

Syndiotactic polypropylene: With this polypropylene, the CH₃ groups are alternately on different sides of the carbon chain in a regular sequence.

Atactic polypropylene: With these polypropylenes, the CH₃ groups are arranged randomly in space with respect to the main chain. The semi-crystalline, isotactic polypropylene is technically important, because only here does high crystallinity provide the technically relevant properties. The **Polystone® P** products manufactured by Röchling are made of isotactic polypropylene.

Furthermore polypropylen is differentiated in:

PP block copolymers

PP block copolymers are very tough thanks to an elastomeric component in the molecular chain (mostly ethylene-propylenrubber) and can be used at temperatures of up to approximately – 30 °C. However, the continuous usage temperature is approximately 10 °C lower compared with homopolymers.

PP homopolymers

PP homopolymers are highly crystalline polypropylene types that, in contrast to copolymers, display greater hardness, stiffness and tensile strength at room temperature. At temperatures around freezing point however, they undergo heavy embrittlement due to their molecular structure.

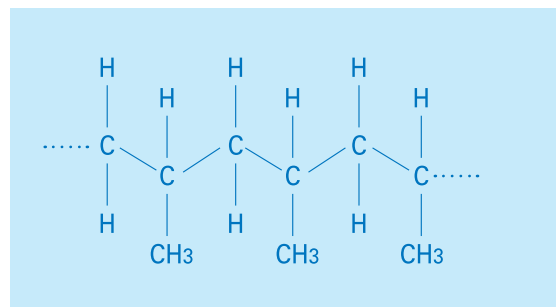

Molecular structure of an isotactic polypropylene

Compared with polyethylene, the polypropylene types are characterised by the following differences:

- Lower density
- Greater rigidity and strength
- Higher melting temperature (between 160 °C and 165 °C)
- Greater dimensional stability in heat
- Polypropylene homopolymers are brittle when cold, PP copolymers on the other hand display good impact strength
- Good electrical insulation properties
- Lower oxidation resistance

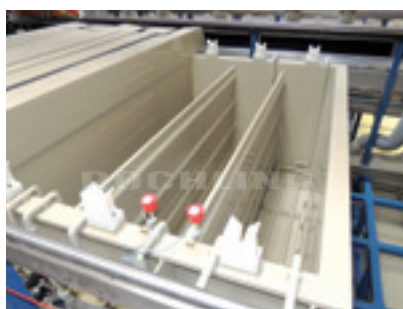

Polystone® P homopolymer grey
Process tanks in a plastic electroplating

Polystone® P homopolymer grey

Polystone® P homopolymer grey is extremely strong and highly resistant to chemicals, corrosion and heat. These characteristics make **Polystone® P homopolymer grey** the ideal material for chemical tanks and plants.

Properties

- High strength
- Very high heat resistance
- Excellent weldability properties
- High chemical and corrosion resistance



Polystone® P block copolymer grey
Process tanks for wastewater treatment

Polystone® P copolymer grey

Polystone® P copolymer materials are outstanding for their toughness at temperatures down to -30 °C, as well as their high strength and high chemical and corrosion resistance. Standard: block copolymer, random copolymer on request.

Properties

- High strength
- Very high impact resistance
- High heat resistance
- Excellent weldability
- High chemical and corrosion resistance



Polystone® P homopolymer natural
Anodisation basin for treating door handles

Polystone® P homopolymer natural

Polystone® P homopolymer natural is extremely strong and highly resistant to chemicals and corrosion.

Properties

- High strength
- Very high heat resistance
- Excellent weldability properties
- High chemical and corrosion resistance



Polystone® PPs EL black
Scrubber

Polystone® PPs EL black

Its range of properties enables **Polystone® PPs EL** to fulfil the requirements that are particularly important for applications in potentially explosive locations and for the protection of electronic components against static discharges. For this reason, **Polystone® PPs EL** is particularly well suited for application in construction of ventilation devices.

Properties

- Flame retardant
- Antistatic
- Electrically conductive



Polystone® PPs grey
Ventilation plant

Polystone® PPs grey

Polystone® PPs grey is a flame retardant material, especially suitable for ventilation systems and equipment manufacture.

Properties

- Flame retardant (B1) acc. to DIN 4102
- High rigidity
- Excellent weldability and processing properties
- Very high chemical resistance

Polyvinyl chloride (PVC)

Polyvinyl chloride is a predominantly amorphous plastic with low crystalline components (approx. 5%). All chlorine atoms are statistically distributed on both sides of the C atoms (atactic arrangement with short syndiotactic segments). The chlorine content is approximately 56.7%. Depending on the manufacturing method, the raw material is handled as a mass (M-PVC), suspension (S-PVC) or emulsion (E-PVC) PVC with fine grains.

The polymerization process of PVC

Mass polymerization

The highest purity due to the low polymerization additive content. It is preferable to use mass polymerides where there are special requirements regarding the product's purity.

Suspension polymerization

A frequently used method of radical polymerization. The carrier medium is normally water. The monomer that is barely soluble or insoluble in water is dispersed in the carrier medium by stirring. The monomer droplet size is between 0.01 and 3 mm diameter. The initiator is soluble in the monomer, i.e. polymerization occurs in the monomer droplet. The monomer droplets are stabilized by a protective colloid.

Emulsion polymerization

In emulsion polymerization, a little water soluble monomer is emulsified in water and polymerized with the aid of a water-soluble radical starter. The polymer chains that occur initially in the aqueous phase come together. By diffusion of other monomers from the droplets into the aqueous phase, the particles can take up monomers and grow.

Additives

Since PVC does not melt but would first decompose, additives must be mixed in before processing. A distinction is made between thermostabilizers (e.g. tin, calcium, zinc or lead stabilizers), lubricants (e.g. wax or fatty acid esters) and colour additives (e.g. titanium dioxide, carbon black). Modifiers, auxiliary agents, minerals, flame protection agents etc. are also mixed in so as to obtain particular properties in a targeted manner. A recipe of this type therefore contains at least 4 and frequently up to 20 components. The powder mixture is heated up by friction in a "hot mixer", during which some of the additives melt and penetrate into the PVC grain or surround it. During a subsequent and fast cooling process ("cooling mixer"), an easily pourable powder is produced that is now called "dryblend" and is either temporarily stored in silos or is sent directly for further processing.

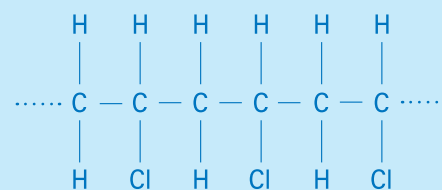

Molecular structure of Polyvinyl chloride (PVC)

The polyvinyl chloride types display the following properties:

- High mechanical strength, rigidity, hardness (modulus of elasticity)
- Good chemical resistance
- Good electrical properties
- Self-extinguishing outside the flame
- Extremely low residual monomer content (in the raw material <1 ppm, in the finished part <100 ppb)
- Low abrasion strength



Trovidur® NL
Inliner in a distillation column
(interior view)



(Exterior view)

Trovidur® NL

Trovidur® NL is a very highly chemical-resistant PVC-U used mainly in the manufacture of chemical tanks and liners.

Properties

- Code colour red
- Uniform physical properties in all directions of sheet thanks to the manufacturing process
- Normal impact resistant
- High resistance to acids, lyes and salt solutions
- Flame retardant, self-extinguishing after removal of flame
- Problem-free processing, when welding, thermoforming and bonding
- Suitable for contact with drinking water and food



Trovidur® EC-N
Ducting system with mist eliminators

Trovidur® EC-N

Trovidur® EC-N is a plasticiser-free PVC with normal impact strength.

Properties

- Normal impact strength
- High resistance to acids, lyes and salt solutions
- Meets the requirements for classification in fire classes B1 acc. to DIN 4102 up to 4 mm thickness
- Self-extinguishing after removal of flame
- Easy processing by welding, thermoforming and bonding



Trovidur® ET
Splash protection for rinsing tank in a clean room technology

Trovidur® ET

Trovidur® ET is a transparent, unplasticised rigid PVC material especially suited for safety equipment in machine and equipment manufacturing.

Properties

- Normal impact strength
- RoHS-compliant
- High transparency
- Flame retardant, self-extinguishing after removal of flame
- Easy processing by welding, thermoforming and bonding
- Good resistance against chemicals

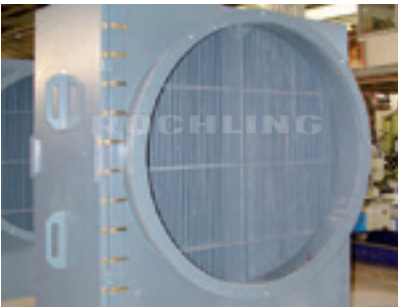

Trovidur® PHT
Mist eliminator

Trovidur® PHT

Trovidur® PHT is a post-chlorinated PVC for chemical tank building.

Properties

- Uniform physical properties in all directions of sheet thanks to the manufacturing process
- Normal impact strength
- High resistance to acids, lyes and salt solutions
- Flame retardant, self-extinguishing after removal of flame
- Problem-free processing when welding, thermoforming and bonding
- Continuous operating temperature up to 90 °C

Polyvinylidene fluoride (PVDF)

PVDF (polyvinylidene fluoride) is a semicrystalline thermoplastic that belongs to the group of fluorine polymers. The fluorine content is around 59%. It can be created by both emulsion and suspension polymerization. The products made of **Polystone® PVDF FM** that are manufactured by Röchling are made via suspension polymerization, as this method gives the polymerizate a higher crystallinity and melting temperature.

Fluoroplastics are used in chemical engineering due to their good chemical resistance, mechanical properties and thermal stability. The strong bonding between the very electro-negative fluorine and the carbon is the reason for the high chemical resistance of PVDF.

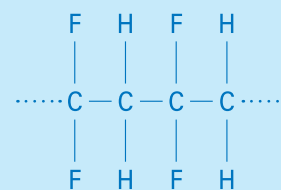

Molecular structure of PVDF



Polystone® PVDF FM
Chrome evaporator

Polystone® PVDF FM

Polystone® PVDF FM is a highly temperature-resistant, strong material.

Properties

- High mechanical strength, stiffness and tenacity
- Relatively high temperature resistance (-10 °C to 150 °C)
- Outstanding resistance to acids
- Physiologically harmless
- Good resistance to abrasion
- Very good UV resistance
- Excellent sterilisability
- Flame retardant
- Excellent weldability



Polystone® PVDF GK
Inliner of a chrom-plating bath

Polystone® PVDF SK/GK

Polystone® PVDF SK/GK sheets are backed on one side to enable them to be bonded with other materials. The material used for the coating is either a polyester stretch (SK) or, in the case of strongly diffusing chemicals and/or high temperature fluctuations, knitted glass fibre (GK). **Polystone® PVDF GK** offers good bonding properties e.g. for composite tanks.

Properties

- Excellent weldability and processing properties
- Especially firm adhesion in the composite system and therefore especially suitable for tank and plant construction
- Especially high resistance to acids
- Very high heat resistance
- Excellent ageing properties

Ethylene chlorotrifluorethylene (E-CTFE)

Ethylene chlorotrifluorethylene is a partly fluorinated thermoplastic. The fluorine content is higher compared to PVDF. Based on its chemical structure – a 1:1 alternating copolymer of ethylene and chlorotrifluorethylene – E-CTFE offers unique properties.

The sheets manufactured by Röchling are produced in a press or extrusion procedure.

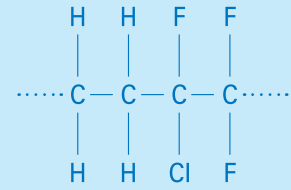

Molecular structure of E-CTFE



Polystone® E-CTFE
Safety box in the semiconductor industry

Polystone® E-CTFE S

Polystone® E-CTFE is a partially fluorinated plastic with very good chemical resistance and high purity.

Properties

- Excellent chemical resistance against numerous chemicals e.g. acids and alkalis
- Good electrical properties
- Flame retardant (UL 94 V0)
- Very high purity
- Very smooth surface

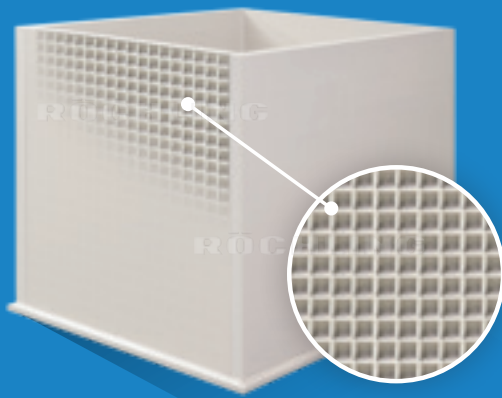

Polystone® P CubX®

The tank construction sheet Polystone® P CubX® featuring a unique inner cube structure for outstanding stiffness properties. Potential steel reinforcement reductions of up to 100%. The time saving in tank construction is substantial.

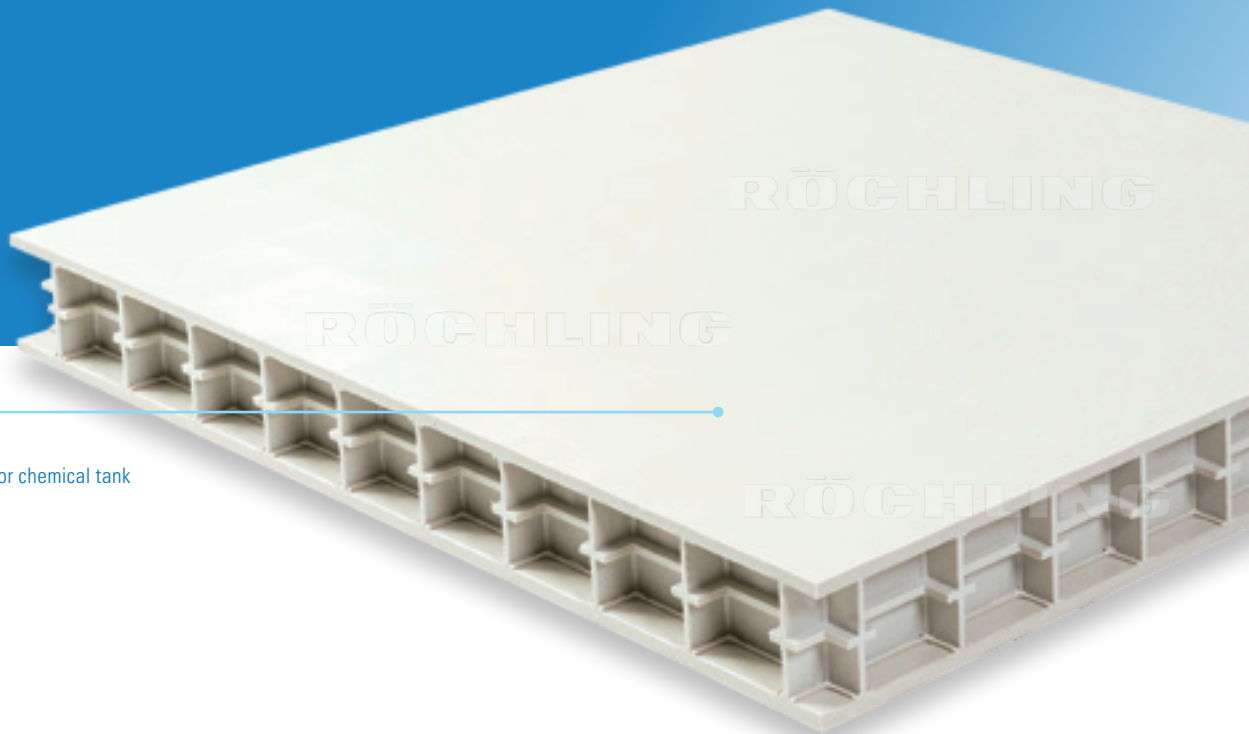

Polystone® P CubX®:
Developed especially for chemical tank and plant construction

Fast, safe and efficient rectangular tank construction

As an expert in tank construction, you know: even quite small rectangular tanks made of thermoplastics normally require elaborate steel reinforcement. Cladding with plastic profiles, which have to be elaborately cut to size and welded, is required to protect the steel reinforcement against corrosion.

With Polystone® P CubX®, Röchling has now developed a **completely new tank construction sheet** with an inner cube structure that allows for **quicker and easier rectangular tank construction**.

The special feature is the sheet design, which combines **very high longitudinal and transverse stiffness** in the sheet itself. Polystone® P CubX® consists internally of a homogeneous,

rectangular grid pattern, welded to two sheets on its outsides, which form the sheet surface. The result is an innovative construction sheet that combines light weight and ease of handling with very high longitudinal and transverse rigidity.

The sheet, which was specially developed for tank construction, is also suitable for permanent contact with a large number of chemical media thanks to the proven chemical resistance of Röchling materials. The considerable reduction of steel reinforcements that would otherwise be required for thermoplastic rectangular tanks also results in **significant time savings** in tank manufacturing.

**Fast production:**

Rinsing water tank made of Polystone® P CubX® without steel reinforcement

Polystone® P CubX® offers several advantages for the construction of your rectangular tank:



Reduction of steel reinforcements

Depending on the size of the tank, rectangular tanks made of Polystone® P CubX® require less or even no plastic-coated steel reinforcements due to the high rigidity of the sheet. This significantly reduces the number of necessary welds and saves time and resources.



Easy handling

Tests in our in-house material laboratory show: A Polystone® P CubX® sheet with a thickness of 57 mm has the same stiffness as a solid plastic sheet made of PP with a **thickness of 35 mm**, but weighs only half as much. This simplifies the handling of the sheets. Also ideal for tank repairs and retrofits.



High level of process safety

Polystone® P CubX® increases the process reliability of your rectangular tank when compared to solid plastic sheets. If leakage occurs, the leaking fluid accumulates locally and is limited in the interior of the sheet. **The operator thus has more time to take appropriate measures.** For leakage monitoring, Polystone® P CubX® sheets are already equipped with a recess as standard, which forms a cavity in the finished tank for interior monitoring, by wire for example. **It can also be used as a collecting channel for external optical monitoring.**



Thermal insulation

Polystone® P CubX® offers good thermal insulation thanks to the air trapped in the hollow chambers.

Elaborate and costly insulation work can be reduced or saved.



Polystone® P CubX®
the innovative sheet with the inner cube structure

Applications

- Rectangular tank, for example, for galvanising plants, steel pickling plants, sewage technology, cleaning systems, purification systems, tank fittings
- Lids and partitions for round tanks
- Enclosures for ventilation systems
- Retrofitting and repair of rectangular tanks

Properties

- High longitudinal and transversal stiffness
- High chemical resistance
- Light weight, easy handling
- Good thermal insulation
- Easy to weld by means of heating element butt welding, hot gas welding, extrusion welding



Standard equipment:
Recess for leakage monitoring



Polystone® P CubX®: can be very easily processed using common welding methods, heating element butt, hot gas and extrusion welding as well as all machining methods



Polystone® Safe-Tec C

Polystone® Safe-Tec C is a multi-layer and grained sheet which has a special non-skid surface and at the same time high chemical resistance.

Contact with chemicals

It has been developed by Röchling especially for bases and treads in chemical plant and tank construction. The sheet produced in the coextrusion process is ideally suited for fields where contact of the sheet with chemicals cannot be excluded, for example, in the vicinity of a plant for chemical surface treatment.

Properties

- Non-skid properties tested in accordance with DIN 51130
- High chemical resistance
- Surfaces and intersections can be welded together (extrusion welding, hot-plate butt welding)
- Almost no moisture absorption, therefore no swelling
- Simple processing



Polystone® Safe-Tec
in drainage pipes



Polystone® Safe-Tec C is suitable for areas where contact with chemicals cannot be excluded

Chemical resistance

- Alkali solutions
- Salt solutions
- Organic acids
- Inorganic acids (excepting strongly oxidising acids)
- Alcohol
- Water
- Oils

Applications

- Bases and treads in chemical plant and tank construction
- Chemical industry
- Clean-room technology

Surface

Polystone® Safe-Tec is available with two different surface structures:

- "Cubic grain" – three-dimensional, cube-shaped grain
- Fine grain

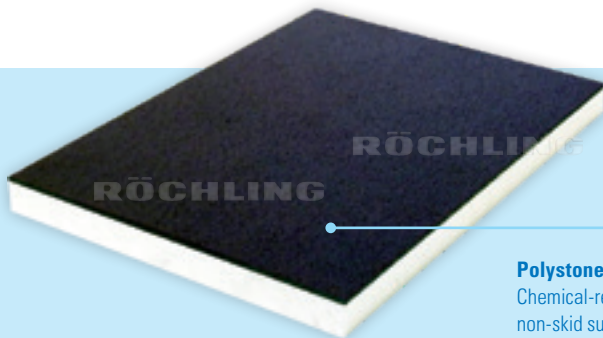

Polystone® Safe-Tec C
Chemical-resistant and non-skid surface



Walls of a pickling room lined with Polystone® G HD blue ...



... and floor made of Polystone Safe-Tec C

Foamlite®

Foamlite® is the innovative plastic sheet with foamed inner core. In the engineering phase, Röchling was, above all, concerned with weight reduction. Compared to a comparable compact sheet, it offers a weight advantage of 30 percent.

Apart from the low weight, the **Foamlite®** sheet gains high mechanical stability through its closed-cell structure.

For a host of applications, this offers distinct cost benefits through easier handling and design adaptations.

Superior surface quality

- Option of smooth surface or grained on both sides with high scratch resistance
- Slip-resistant surface "cubic grain" available

Foamlite® P

With a density of 0.65 g/cm³, **Foamlite® P** is clearly lighter than a sheet made of compact polypropylene with 0.915 g/cm³.

Application in tank construction

With its good mechanical properties and excellent chemical resistance, **Foamlite® P** is especially tailored to application in chemical tank and plant construction. Here, **Foamlite® P** offers cost benefits due to its low weight, for example, as tank covers.

At the same time, **Foamlite®** can be provided with an "integrated hinge" by a 90 degree V notch being cut into the sheet surface. The high flexural-fatigue strength enables the sheet to be bent up to 40,000 times without breaking.

Moreover, costs for accessories and their assembly can also be saved on in many applications through the additional hinge effect.

Easily weldable

What is more, **Foamlite® P** can be very easily welded with other **Foamlite® P** types in extrusion and high-speed hot-air/gas-welding procedures. **Foamlite® P** can be drilled, sawn, cut and bolted with the usual tools as also used for wood.

Foamlite® G

With a density of 0.70 g/cm³, **Foamlite® G** is over 30 percent lighter than compact polyethylene. A sheet 2,000 x 1,000 x 10 mm in size is therefore about 6 kilogrammes lighter. This creates benefits in handling and dimensioning constructions.

Suitable for moist and wet areas

Foamlite® G has a high surface quality, optionally smooth or grained, and can be processed very well. The very low water absorption makes **Foamlite® G** particularly suitable for applications in moist and wet areas. The additional UV-stabilised variant is available for outdoor applications.



By cutting a V notch into the sheet surface a hinge can be produced with **Foamlite® P**



Foamlite® P grey
Mobile hub of a galvanic line (installed)



Foamlite® P cubic grain as a slip-resistant floor surface of a paint shop in the automotive industry



Foamlite® P grey
Cover flaps over a galvanic tank

Become flexible with Polystone® P flex grey

The flexible weldable sheet for tank building

With Polystone® P flex grey we can now offer you a flexible material that

- combines **high elasticity** with **good weldability**
- and is **resistant to chemicals**.

This gives you a whole new range of options when it comes to the construction of chemical tanks and plants.

Your advantages

As an expert you will know that conventional flexible materials are resistant to chemicals but cannot be welded with PP. Until now you have been unable to exploit the potential of flexible materials for your tanks and plants. Polystone® P flex grey

- allows you to selectively compensate thermal and mechanical expansion,
- so there is no need for tank linings to be thermoformed.

New design options:
Polystone® P flex grey is flexible & weldable at the same time

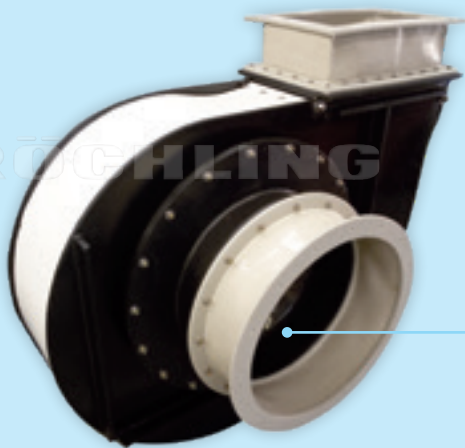

Ventilating systems:
Connections on ventilators made of Polystone® P flex grey

Tank clearance: Flexible connection with Polystone® P flex grey



Accident prevention: Squeeze protection on the hinged cover of a galvanic plant made of Polystone® P flex grey

Properties

- Excellent flexibility
- High chemical resistance
- Good weldability with PP
- Can balance thermal and mechanical expansions

Areas of application

Chemical tank and plant construction:

- Galvanic plants
- Steel pickling plants
- Ventilating systems
- Exhaust air cleaning plants

Welding rods

For nearly all sheets made of thermoplastics for use in construction of chemical tanks and plants, Röchling offers the corresponding welding rods.

Röchling supplies welding rods on rolls, coils or alternatively as bars with a length of 1 or 2 metres.

Properties

- Excellent weldability properties
- All common cross sections as per DVS 2211 available
- Special products available on request

Delivery program welding rods PE/PP/PVDF/E-CTFE

Polystone® G HD black, Polystone® G black B 100, Polystone® G black B 100-RC, Polystone® G HD blue, Polystone® G blue B 100-RC, Polystone® G EL black, Polystone® P homopolymer grey, Polystone® P block-copolymer, Polystone® P random-copolymer, Polystone® PPs EL black, Polystone® PPs grey, Polystone® PVDF FM¹⁾ Polystone® E-CTFE ¹⁾

		mm	↔ Δ mm	⤴ Δ mm	Coil	Loose roll	Bar 2000 mm
● Round DVS 2211	RS/2	∅2	±0.2	±0.2	3 kg	5 kg	3 kg
	RS/3	∅3	±0.2	±0.2	3 kg	5 kg	3 kg
	RS/4	∅4	-0.3/+0.2	-0.3/+0.2	3 kg	5 kg	3 kg
	RS/5	∅5	-0.4/+0.2	-0.4/+0.2	3 kg	5 kg	3 kg
● Triangle 80° DVS 2211	DK/80-4	4.0 x 3.0	±0.3	+0/-0.4	3 kg	5 kg	3 kg
	DK/80-4.3	4.3 x 3.0	±0.3	+0/-0.4	3 kg	5 kg	3 kg
	DK/80-5	5.0 x 3.5	±0.3	+0/-0.4	3 kg	5 kg	3 kg
	DK/80-6	6.0 x 4.5	±0.3	+0/-0.4	3 kg	5 kg	3 kg
	DK/80-7	7.0 x 5.3	±0.4	+0/-0.4	3 kg	5 kg	3 kg
▼ Triangle 90° DVS 2211	DK/90-5.7	5.7 x 3.8	-0.5/+0.1	+0/-0.4	3 kg	5 kg	3 kg
▼ Triangle 70° DVS 2211	DK/70-7	7.0 x 5.0	-0.3/-0.9	+0/-0.4	3 kg	5 kg	3 kg
▼ Triangle 90° special	DK/90-5	5.0 x 3.2	±0.3	+0/-0.4	3 kg	5 kg	3 kg
● Oval	OS-5	5.0 x 3.0	±0.3	±0.3	3 kg	5 kg	3 kg
● Triplet 90°	DR/80-5	5.0 x 3.4	±0.3	+0/-0.4	3 kg	5 kg	3 kg

1) only available as 2 kg roll

Delivery program welding rods PVC

Trovidur® NL, Trovidur® EC-N, Trovidur® PHT, Trovidur® HT-X

		mm	↔ ⤴ Δ mm	Loose roll	Bar 2000 mm	Bar 1000 mm
● Round DVS 2211	S DMS:2	∅2	±0.2	–	3 kg	–
	S DMS:3	∅3	±0.2	8 kg	3 kg	–
	S DMS:4	∅4	±0.2	–	3 kg	–
	S DMS:5	∅5	±0.2	–	3 kg	–
● Triangle 80° DVS 2211	80-4.3	3 x 3 x 4.3	–	–	–	3 kg
	80-6	4 x 4 x 6	–	–	–	–
	80-7	5 x 5 x 7	–	–	–	3 kg
	80-8	6 x 6 x 8	–	–	–	–
▼ Triangle 90° DVS 2211	90-4	3 x 3 x 4.3	–	–	–	3 kg
	90-6	4.7 x 4.7 x 6	–	–	–	3 kg
● Double Core	–	6.1 x 3.1	–	–	–	3 kg
● Triplet	–	5.0 x 3.5	–	–	–	3 kg
● DK 100	–	5.55 x 3.0	–	–	–	3 kg
● DK 200	–	6.45 x 3.45	–	–	–	3 kg
● Profile a	–	7.0 x 3.0	–	–	–	3 kg
● Profile b	–	5.5 x 2.5	–	–	–	3 kg

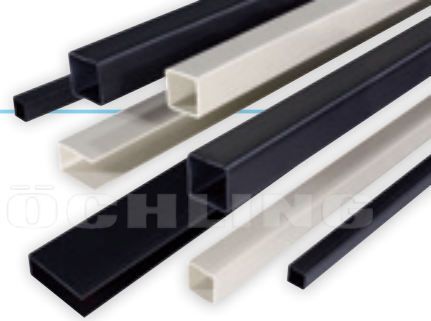

RÖCHLING

Prerequisites for the weldability of plastics

The prerequisites for the hot-plate butt welding of **PE 80 and PE 100 materials** are described in DVS 2207-1 (08.15) in accordance with DIN 8074 and DIN 8075. Accordingly, "suitability within the hot-melt compound flow rate MFR 190/5 from 0.3 to 1.7 g/10 min or 0.2 to 0.7 g/10 min can be assumed".

DVS 2207-11 (09.08) describes the prerequisites for the hot-plate butt welding of **PP-H, PP-B and PP-R materials** according to DIN 8077 and DIN 8078. Accordingly, "suitability within the hot-melt compound flow rate MFR 190/5 from 0.4 to 1.0 g/10 min can be assumed. This range roughly corresponds to the hot-melt compound flow rate MFR 230/2.16 from 0.2 to 0.6 g/10 min".

In DVS 2207-15 (12.05), the prerequisites for the hot-plate butt welding of

PVDF materials are described. Accordingly, "with density of 1.7 to 1.8 g/cm³, suitability can be assumed within the hot-melt compound flow rate MFR 230/2.16 from 1.0 to 25 g/10 min".

If the materials to be joined together meet these prerequisites, it can be assumed that the two components can be welded together.

DVS 2207-1 continues: "With the hot-melt compound flow rates deviating from this, verification of suitability can be conducted in the tensile-creep test in accordance with DVS 2203-4 and supplementary sheet 1." Should the hot-melt compound flow rates lie in the above-mentioned ranges, verification of suitability is therefore not necessary. The hot-melt compound flow rates for the thermoplastics manufactured by Röchling for chemical-tank and plant construction are specified in the technical data sheets and factory certificates.

PP-B welding rods for sheet material made of PP-H

Invariably arising in the area of welding seams are small nicks which may lead, under unfavourable circumstances, to cracks in the tank material. To minimise the danger of damage to the tanks, a welding rod should be used that is slightly notch-sensitive. This is why Röchling recommends the application of welding rods made of PP-B, including for welding together sheet material made of PP-H. Röchling changed over their storage programme more than six years ago and offers the welding rods made of **Polystone® P copolymer grey** as standard. Regardless of that, delivery of welding rods made of **Polystone® P homopolymer grey** is further possible.

U-profiles and square tubes

Polystone® U-profiles and square tubes are produced from the same moulding compound, as the corresponding welding

rod and the sheets. This ensures identical material properties and best processing properties for the complete tank.

Delivery program U-profiles and square tubes

Polystone® G, Polystone® G black B 100 ¹⁾, Polystone® P homopolymer, Polystone® P copolymer ¹⁾, Polystone® PVDF FM ¹⁾

Colours: black, grey	L 5000	↔ mm	↕ mm	s mm	
U-profiles	U01	49	46	4	
	U02	49	72	4	
	U04	49	112	4	
	U05	49	132	4	
	U06	69	72	4	
	U07	69	92	4	
	U08	69	112	4	
	U09	69	132	4	
	U11	69	153	4	
	U12	90	92	4	
	Square tubes	H01	35	35	2
		H03	35	35	3
H05		35	35	4	
H07		50	50	4	
H11		60	60	4	
H12		68	68	3	
H14		52	52	2.5	

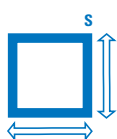
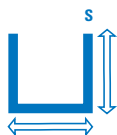

Minimum edge radius 0.5 mm. Other colours and dimensions on request. Not all dimensions and types available ex stock. ¹⁾ not available ex stock

Röchling offers a complete system for:

- Polystone® G HD black
- Polystone® G black B 100
- Polystone® P homopolymer grey
- Polystone® P copolymer
- Polystone® PVDF FM

Properties

- High chemical and corrosion resistance
- Long service life
- Excellent weldability and processing properties



Tank with **Polystone® P grey** profiles

RITA[®] 4

- For free standing, pressureless tanks
- Circular and rectangular
- According to guideline DVS
- New calculation methods for rectangular tanks
- Steel profile management tool
- Interactive tool for wind and snow load



RITA[®] 4 Tank calculation program

The RITA[®] 4 software enables manually complicated calculations for rectangular or cylindrical thermoplastic tanks to be performed in a few seconds and the designing of tanks to be optimised with ease. The calculation bases for the program are based on the internationally recognised DVS Guideline 2205. The program also offers a means of designing tanks beyond the scope of the guideline.



The user interface of the tank calculation program was designed along the lines of the well-known Microsoft office applications, thus enabling even beginners to familiarise themselves quickly with the use of the program.

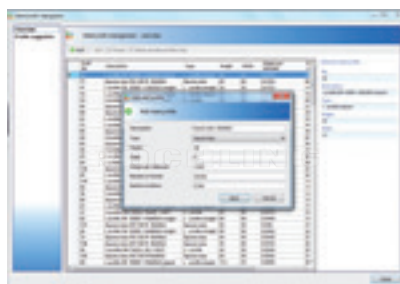

Users can use the steel profile management tool to store individual profiles in the system and incorporate them into the calculation.



Via the new wind and snow load tools, wind and snow can be conveniently defined by selecting the respective zone or interactively by selecting in the map.

TÜV-tested

Before a new program version is released, the calculations done with the program are checked by TÜV Nord [Technical Inspection Agency North] in accordance with a specification previously set. In individual cases the results are also safeguarded by means of FEM analyses.

The calculations in RITA[®] 4 are based on the guideline DVS 2205. This is published in the pocket book "DVS Technical Codes on Plastics Joining Technologies" available from DVS Media AG: www.dvs-media.eu



Demo version

If you have any queries about the operation, functionality or purchase of RITA[®] 4, please contact RITA@roebling-plastics.com

Design variants

Round tanks

RITA® 4 offers a means of dimensioning tanks in conformity to the new supplementary sheets to DVS guideline 2205 with a conical and sloping bottom. At the same time the skirt and supporting structure for the bottom are calculated.

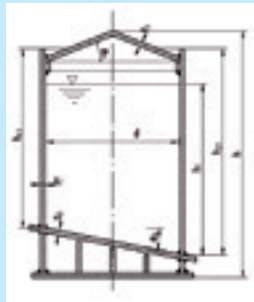
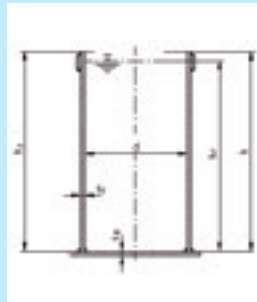
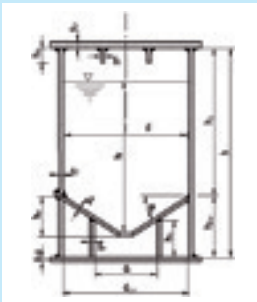

Cylindrical tank calculated with RITA® 4 for installation in a German earthquake zone

Rectangular tanks

Various design variants are possible for rectangular tanks:

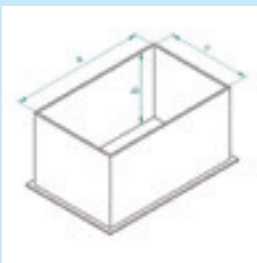

without reinforcement

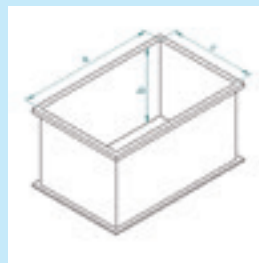

with edge reinforcement

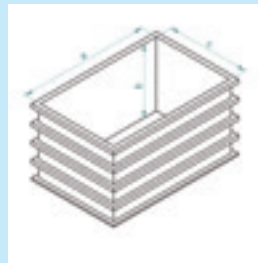

with all-round reinforcement

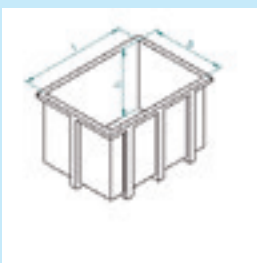

with yoke reinforcement

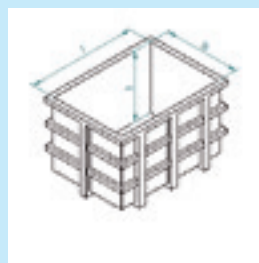

with cross-ribbing



Yoke reinforced rectangular tank calculated using RITA® 4

Chemical resistance

A mutual influence may result when a plastic comes into contact with other materials such as air, gas, water and natural chemical substances. Whilst solid materials do not usually cause any change in the plastics apart from possible abrasions and the removal of low molecular additives (such as plasticisers), even water in the strict sense of the word has an influence. This is all the more so with liquid chemicals. Reversible and irreversible changes may be caused, particularly in conjunction with heat and light, the extent of such changes increasing with the length of exposure.

It follows that the major factors determining resistance to chemicals are temperature, period of exposure, concentration and "aggressiveness" of the medium. It should be added that materials react differently to such influences, depending on whether they are at rest or under stress, i.e. whether a mechanical load is imposed at the same time.

Behaviour of metals exposed to chemicals

In metals, the fact that the atoms are closely packed in the crystal structure means that penetration of the liquid or gas molecules is virtually excluded, except at the crystal boundaries. For this reason, the metal is attacked, or corroded, by chemical or electro-chemical processes virtually only at those places which come into direct contact with the corrosive medium, i.e. only at the surfaces of the metal.

If the reaction products (oxides, sulphides, chlorides or other metal salts) are soluble or easily carried away, the metal surface is laid bare time after time to react again with the corrosive until no metal is left. It is simple to establish the concomitant loss of weight and, from the reduction in the cross section, to arrive at a figure for the loss of strength.

Behaviour of plastics exposed to chemicals

In polymers, however, the methods of attack are completely different. The intermolecular attractions (van der Waal's forces) are far smaller in polymers than in metals (1/100 to 1/1000). This makes the spaces between the large, awkwardly shaped and only "matted" or "convoluted" molecule chains of the thermoplastics under consideration here so large that the comparatively tiny gas and liquid molecules can easily permeate and fill them. This means that the influence brought to bear on the plastics is no longer limited to the coated surface but occurs throughout their depth and thus represents a much more differentiated process.

When considering the effect of attacking media on plastics, it is possible to differentiate between those media which act physically and those which act chemically.



The liquids and gases used in exhaust-air cleaning plants are often severely corrosive. Thermoplastics are used here because of their special corrosion resistance.

Chemically active media

Immediately during the absorption into the surface of the plastic, chemically active media cause chemical reactions to occur with the molecules of the plastics and with any additives (pigments, stabilisers, etc.) that might be present. The chemical attack leads to oxidation, chain breakage or cross-linking. These lead to irreversible changes in the target materials.

Physically active media

This is not necessarily the case with media having a physical mode of action. After absorption into the surface, they spread into the plastic and occupy the free spaces between macromolecules and into microscopic defects and cavities, leading to swelling.

Essential influences on the chemical resistance

In order to assess the resistance of a material to the effects of chemicals, it is important to remember that it is dependent on many factors. The essential factors of influence on the chemical resistance of materials are

- The temperature
- The period of exposure
- The mechanical stress
- The concentration of the medium

Influence of the temperature

Since all the chemical and physical processes affecting resistance develop faster as the temperature increases, clearly, as a rule, the resistance decreases to a greater or lesser extent as the temperature rises. Consequently, this behaviour can also be used to predict the long-term behaviour. If there are results of immersion tests at temperatures which are higher than that desired, then the behaviour during long-term exposure at the desired lower temperature can be estimated from these results.

Influence of the period of exposure

As a rule, chemical resistance falls as the period of exposure increases. By way of departure, this rule does not apply to those media which do not chemically attack the plastic and have only limited solubility in the plastic when in contact with the plastic at the specified temperature. As the mass increases over the course of time the limited solubility is indicated by the occurrence of a degree of saturation. If this saturation value is relatively low, as with, for example, construction materials and the medium water and its low concentration solutions of salts, acids and bases, then the plastic is chemically resistant to such media since its characteristics do not change significantly, even after many years of exposure.

Influence of mechanical stresses

Many materials, including plastics, exhibit stress cracking, as a result of the conditions of use. Cracks can appear in the material as a result of subjecting a plastic to tensile loading in air which exceeds a certain stress or extension but is, however, lower than its apparent yield point in the accelerated test. Such cracks, which sometimes do not appear for many years, are known as stress cracks.

The stresses which cause such cracks are either internal stresses caused by the processing conditions or external stresses as a result of external mechanical loading or a combination of the two. Simultaneous exposure to certain chemical media can, under certain circumstances, drastically reduce the time before cracking occurs. This phenomenon is known as "environmental stress cracking" (ESC) or simply "stress cracking". Stress cracks can completely penetrate the wall of a plastic part and thus create fracture surfaces or they may stop as soon as they come into contact with regions of sufficiently low stresses or extensions or different material structures.

There is no straightforward and unambiguous explanation which covers all cases of stress cracking. It is known, for example, that polar liquids, aqueous solutions of surface-active substances or distilled oils can cause stress cracking if a plastic part is exposed to them and, at the same time, has high internal stresses or for example, is subject to tensile or flexural stress. Without testing a medium beforehand, it is not possible to say whether it causes stress cracking or not.

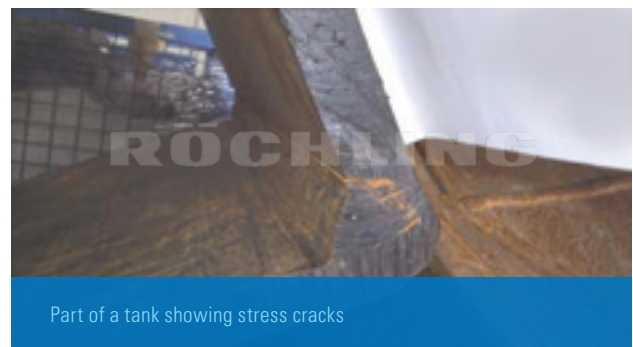

Influence of the concentration

In the case of solutions of two media, one of which attacks the plastic under consideration whilst the other is inert, the chemical resistance of the particular plastic generally decreases as the proportion of the aggressive medium in the neutral medium increases, as for example, in the case of mixtures of sulphuric acid and water.

Definition of the chemical resistance

At the planning stage of tanks, plants and equipments the resistance of the plastic against the attacking medium to be stored or used in the process has to be evaluated. Classification of the materials into three levels is widely used:

- **Resistant**

The material is generally regarded as suitable.

- **Partly resistant**

The material is attacked by the medium, although it may be used under certain conditions. More extensive testing may be required.

- **Not resistant**

The material is generally regarded as unsuitable.

Immersion test

This three level classification is based on immersion testing according to DIN 16888 or ISO 4433 in which sections of the plastic and test pieces are immersed in an unstressed state in the attacking medium.

The relative change in mass and the changes in characteristics in the tensile test are adopted as the assessment criteria. The period of exposure for this test ranges from 28 to 112 days.

The immersion test is only of limited suitability for gaining information with regard to the applicability of a plastic for chemical tank and plant construction, as the test pieces are exposed to the effect of the attacking medium whilst free from external stress. The immersion test is sufficient to assess PVC-U and PP liners (liner/UP-GF) since the liner is able to withstand extensions of not more than 0.1 to 0.2% from the UP-GF component.

Determination of the chemical reduction factors

For the dimensioning of full thermoplastic tanks the permissible stress is calculated in accordance with DVS 2205 part 1 from the strength coefficient. In order to obtain quantifiable information about the influence of a medium on the plastic's strength and thus on the design of tanks and plants, long-term failure testing under internal hydrostatic pressure is carried out on pipes, in which the usual water filling is replaced by the corresponding medium. A comparison of the long-term performance of the same pipe with a water filling enables the chemical-resistance factors (f_{CR}) to be determined.

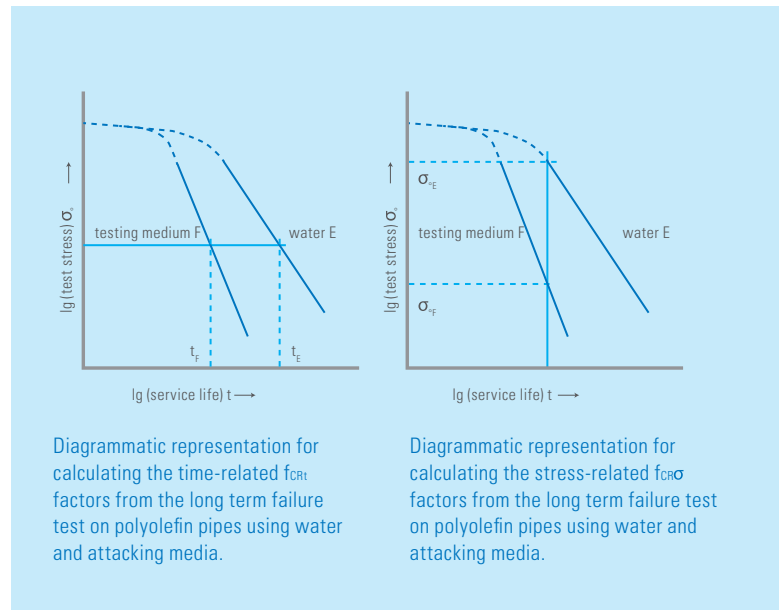

Chemical resistance tables of the DIBt

Corresponding reduction factors, which are published, for example, in the media lists of the German Institute for Civil Engineering (DIBt) can be derived from these chemical-resistance factors. These lists contain data about the most common media used in chemical-tank and plant construction which can be referred to for selecting material for a tank or plant. Over and above this, Röchling has extensive databases and experience regarding the chemical resistance of thermoplastics.

For this reason, when questions arise concerning the chemical resistance of thermoplastics, Röchling recommends contacting our experts, and has set up an e-mail address specifically for this: chemicals@roechling-hpp.com

To be able to provide information about resistance and to make a material recommendation, our application engineers need the following data:

- Designation, concentration and precise composition of the medium
- Temperature of the medium (are temperature fluctuations to be expected?)
- Data concerning the exposure time (constantly in case of a storage tank)

It should be further stated as to whether the material is to be used for an all-thermoplastic tank or as inliner. Ideally, a design of the tank or plant has already been determined, so that any stress occurring in the material can be taken into due consideration.

Critical media

According to the Media Lists 40 of the DIBt (issue September 2017) media with an A_2 factor > 1.4 for an assumed media exposure time of 25 years or with an A_2 factor ≤ 1.4 for a shorter media exposure time are considered "critical".

Generally valid as "critical media" for PE-HD is the following:

Medium	Concentration
Chlorine water ($\text{Cl}_2 \cdot \text{H}_2\text{O}$)	all
Potassium hypochlorite (KOCI , active chlorine ≤ 150 g/l)	—
Sodium hypochlorite (NaOCI , active chlorine ≤ 150 g/l)	—
Nitric acid HNO_4	$\leq 53\%$
Sulfuric acid H_2SO_4	$\leq 96\%$

In earlier issues of the DIBt media lists, reduction factors for these media were stated. However, due to isolated damage, the responsible committee resolved on removing these media from the tables. Here, the applicability of PE-HD for tanks for storing "critical media" should be examined by an expert in each case. A list of corresponding experts is available from the DIBt.

For applications with "critical media", Röchling recommends in many cases the application of PVC or PVDF as the inliner of a GFRP and steel tank alternatively to application of PE-HD as all-thermoplastic tank.

Permeation behaviour

All attacking media penetrate into the plastic to a certain extent. Calculations for permeating attacking media which penetrate through the plastic at high diffusion rates without noticeable changing its characteristics require special tests. Such substances can damage adjacent objects when they seep through the external surface of the tank or pipe wall. Permeation must be taken into account particularly with composite materials. In such cases, the resistance of both the inner liner which is in direct contact with the attacking medium and the outer casing (e.g. GRP or steel) must be specified.

The comparatively high degree of water vapour permeability gains significance in the case of composites of PVDF with a less permeable material. Thus, for example, the water permeability of a GRP layer of the same thickness is clearly lower. Consequently, there may be no voids or cavities in the interface layer between the PVDF and GRP or in the adjacent GRP composite. Otherwise, it may be affected by condensation and, as a consequence of the created osmotic pressure, the liner can become detached causing blistering or damage to the GRP. A suitable resin should be selected in order to prevent the permeation of water vapour. Normal UP resin tends to saponify in the presence of water vapour and increased temperatures.

Weather resistance

Materials like PE or PP that are subjected to sunlight outdoors for an extended period, physical/chemical processes are initiated particularly by the UV component of the sunlight and under the influence of the oxygen in the air. The results are:

- Discoloration (often yellowish)
- Embrittlement (loss of toughness)
- Loss of mechanical properties

The processing methods and thickness of the moulded part have a major influence on the degradation mechanism. Internal stresses and thin walls speed up UV-related degradation. However, this applies only to unstabilised PE or PP. Our own experiments have shown that UV damage can be prevented by the use of additives.

If appropriately stabilised and/or with UV absorbers, PVC semi-finished products achieve service lives of over ten years without any significant change to their range of properties. A low degree of "chalking" of the weather-exposed surface is also crucial to this protection, and is the main reason why no dark colours are appropriate.

PVDF and E-CTFE possess excellent resistance to weathering influences and require no additives for UV stabilisation. Even years of weathering tests on unmodified PVDF and E-CTFE have caused no significant changes to the mechanical properties.

Electrical conductivity

Thermoplastics are normally good electrical insulators. This property is put to specific use in many applications. However, the electrostatic charge on the surface of normal plastics can reach a potential of several kilovolts, which can, for example, trigger explosions or destroy electronic components in the event of an explosion. In the case of dust and air mixtures and particularly in the case of gas and air mixtures, the minimum ignition energies (MIE) are rapidly reached. There are therefore many areas of use in which electrical conductivity or antistatic material behaviour are required. Thermoplastics can be made electrically conductive by the addition of conductive carbon black.

The amount of carbon black added must be sufficiently high that a conductive network is formed. The processing method has a significant influence on the network formation and therefore on the amount of carbon black added. In order to achieve the same volume resistance, much less carbon black is required for pressed materials than for extruded products.



Polystone® G HD black Housing of a ventilation plant on a hall roof. Here, good weather resistance is absolutely essential.

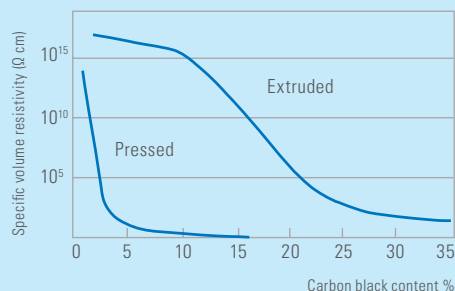

Specific volume resistivity as a function of the carbon black concentration

The electrically conductive materials **Polystone® G EL black** and **Polystone® PPs EL black** manufactured by Röchling come to use in chemical-tank and plant construction. They have a specific volume resistance and surface resistance of <104 Ohm.



Polystone® G EL black
Exhaust-air scrubbers

Fire behaviour

The flammability of plastics is often a technical problem and an obstacle to their use. Various testing methods are used for the fire behavior classifications. In DIN 4102, the materials are divided up into flammable and non-flammable. In their standard versions,

Polystone® G and P belong to the normal inflammable plastics. Through the addition of flame protection agents, **Polystone® PPs** falls into Class B1 (flame retardant).

According to this standard, all **Trovidur®** materials are categorised by definition as at least "self-extinguishing outside the flame" (B2). The classes are:

- B1 – flame retardant
- B2 – normally inflammable
- B3 – highly inflammable

Polystone® PVDF FM on the other hand is slightly inflammable and is self-extinguishing following removal of the ignition source. In addition, only a small amount of smoke is produced when PVDF is burned. Basically two testing methods are employed to assess flammability.

In the test as defined by ISO 4589, it is determined how much oxygen must be available to a plastic so that it catches fire and continues to burn. The oxygen index defines the concentration of oxygen (vol. %) in a nitrogen/oxygen mixture that is required in order to sustain combustion.

In this test, the values for PVDF are significantly higher than those for the polyolefines. Another assessment of the fire behaviour is the test in accordance with UL 94 (Underwriters Laboratories). In a test carried out on a 0.8 mm sample, PVDF achieved the best possible categorisation of "V0". Absolutely no flame formation was observed. PVDF remains consistent and does not flow.

Fire behaviour of Polystone® and Trovidur® materials

Material	DIN 4102	UL 94
Polystone® G (PE-HD)	B2	HB
Polystone® P	B2	HB
Polystone® PPs	B1	V2
Polystone® PPs EL black	B1	V0
Polystone® PVDF FM	B1	V0
Trovidur® ET	B1, 1...4 mm	V0
Trovidur® NL	B1, 1...3 mm	V0
Trovidur® EC-N	B1, 1...4 mm	V0, 5V
Trovidur® PHT	–	V0
Polystone® Safe-Tec C	B2	HB
Foamlite® P	B2	HB
Foamlite® G	B2	HB



There are high requirements made on fire behaviour particularly when plastics are used for ventilation plants

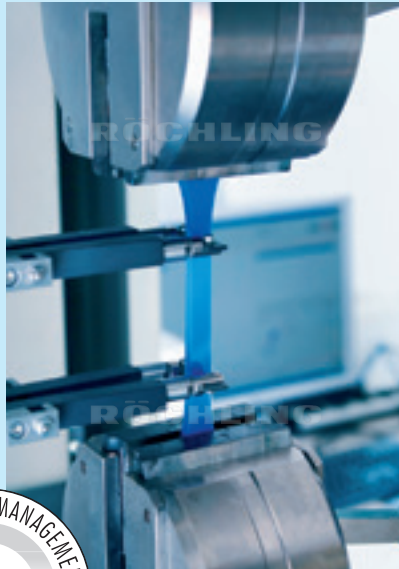

Test methods

Damage to a tank or plant, in which highly aggressive chemicals are stored, may have serious consequences for persons and the environment. For this very reason, high requirements are made on the thermoplastics used in chemical-tank and plant construction.

In Röchling's laboratories more than 700 standards are available. Over 350 tests can be conducted at the various locations.

They include:

- FTIR (Fourier Transformations InfraRed)
- Bending angle
- FNCT
- DSC/OIT
- Determination of impact resistance
- High-voltage tests up to 200,000 Volt
- Weathering tests
- Wear tests
- Mechanical tests from plus 200 °C down to minus 100 °C
- Electronic colour measurement

The most important testing procedures for the application of plastics in chemical-tank and plant construction are described below:

FNCT (Full Notch Creep Test)

The FNCT is used by Röchling to determine the resistance of our plastic materials against slow crack growth. The test specimen is provided with an all-round full notch and suspended in a wetting agent solution at 80 °C to 95 °C under tensile stress.

Dimension of specimen: 10 x 10 x 100 mm³,
applied tensile stress: 4 – 5 MPa

The longer the time until a fracture of the specimen the better the resistance of the material against slow crack growth.

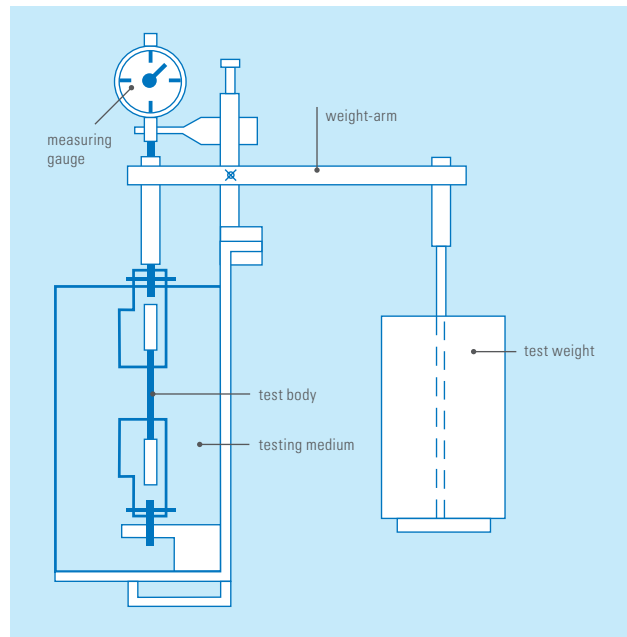

The test rig is similar to other tensile creep tests



Stress cracks



Specimen with all-round full notch



Samples in the automatic sample changer

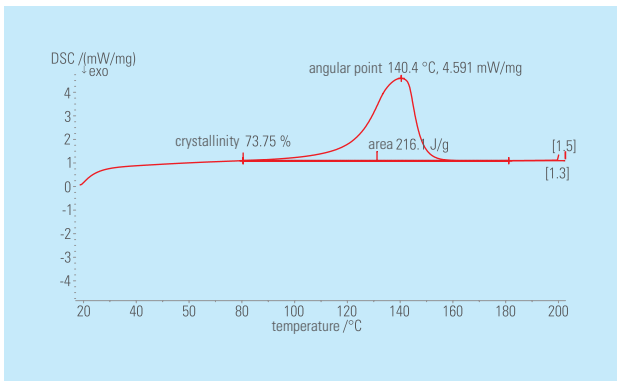

Typical diagram of a DSC analysis

DSC/OIT

- Two complete procedures in one device.
 - DSC (Differential Scanning Calometry)
 - OIT (Oxidation Induction Time)
- Computer supported analysis unit
- Measuring of the difference between the heat flow of a specimen being examined and the heat flow of a reference material as a function of temperature and/or time.
- Required specimen mass: Less than 10 milligrammes!

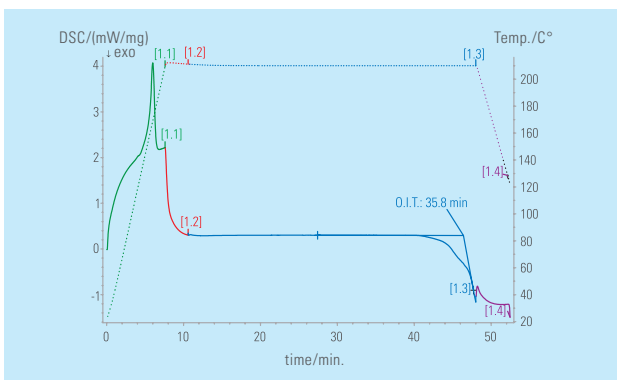

Typical diagram of an OIT analysis



Insertion of a specimen into the measuring cell

Determination of impact resistance

For the determination of the impact resistance of our materials a notched specimen is subjected in an impact fixture with the ends on two buttresses to impact stress using the swing hammer. The impact energy and the sample cross section must be harmonised to each other so that the sample either breaks or is pulled through the buttresses.

The impact work absorbed during the breakage is measured, referred to the specimen's initial cross section. The result is given in kilojoules per square meter kJ/m^2 .



Device for the determination of the impact resistance



Test set-up for the determination of the impact resistance

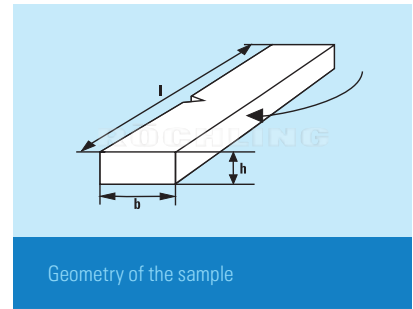

Geometry of the sample

Bending angle

One of the most important test methods for the determination of the quality of welded joints is the bend test. Using a specified ram geometry and a defined distance between the axes the bend angle is determined as the difference between the initial angle and the final angle when either a fracture occurs or a crack in the specimen is visible.

The bend angle, the ram displacement while bending and the fracture appearance provide a guide to the ductility of a welded joint and hence the weld quality:

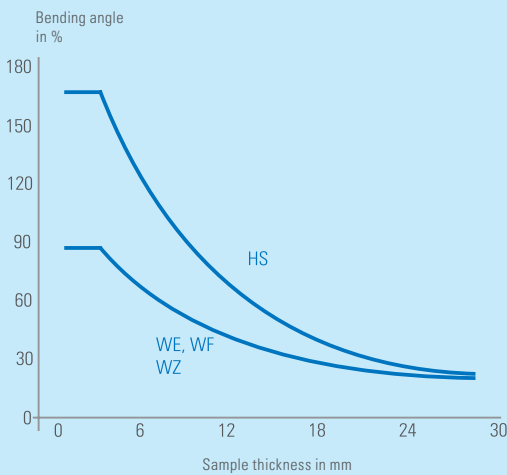

Minimum bending angle for PE-HD (PE 80, PE 100) according to DVS 2203-1 supplement 3















Laboratory welding machine for welding tests



Determination of the bending angle

Our offer at a glance

	PE, PP, PVDF, E-CTFE	PVC	
Material	Polystone® G HD black	Polystone® PPs EL black	Trovidur® NL
	Polystone® G HD blue	Polystone® PVDF SK/GK	Trovidur® EC-N
	Polystone® G blue B 100-RC	Polystone® E-CTFE	Trovidur® ET
	Polystone® G EL black	Polystone® Safe-Tec C	Trovidur® PHT
	Polystone® G HD SK/GK black	Foamlite® P	
	Polystone® P homopolymer grey	Foamlite® G	
	Polystone® P block-copolymer grey	Polystone® P flex	
	Polystone® P random-copolymer grey		
	Polystone® P homopolymer natural		
Extruded sheets	 1,000 x 1,000 mm	2,000 x 1,000 mm	
	2,000 x 1,000 mm	2,440 x 1,220 mm	
	2,440 x 1,220 mm	3,000 x 1,500 mm	
	3,000 x 1,500 mm	4,000 x 2,000 mm	
	4.000 x 2.000 mm		
	s 1-50 mm	s 1-6 mm	
Compression moulded sheets	 2,000 x 1,000 mm	1,000 x 1,000 mm	
	3,000 x 1,250 mm	2,000 x 1,000 mm	
	4,000 x 2,000 mm	2,440 x 1,220 mm	
	6,000 x 1,000 mm		
	6,000 x 2,000 mm		
	6,000 x 2,500 mm		
Cross-ribbed twin-wall sheets Polystone® P CubX®	2,000 x 1,500 mm s 57 mm		
Round rods	∅ 8 – 300 mm	∅ 8 – 300 mm	
	∅ 1,000 mm	∅ 1,000 mm	
	∅ 2,000 mm	∅ 2,000 mm	
	∅ 2,150 mm		
Profiles	 extruded		
Welding rods			
			
			
			
			
			

*skived sheets



RÖCHLING

Röchling Engineering Plastics SE & Co. KG

Röchlingstr. 1
49733 Haren | Germany
Tel. +49 5934 701-0
Fax +49 5934 701-299
info@roechling-plastics.com

Röchling Engineering Plastics SE & Co. KG

Site Troisdorf
Mülheimer Str. 26 | Geb. 115
53840 Troisdorf | Germany
Tel. +49 2241 4820-0
Fax +49 2241 4820-100
info@roechling-plastics.com

Röchling Sustaplast SE & Co. KG

Sustaplast-Str. 1
56112 Lahnstein | Germany
Tel. +49 2621 693-0
Fax +49 2621 693-170
info@sustaplast.de



Röchling Industrial. Empowering Industry.

www.roechling.com