

INSTRUCTION OPTIONS

CONTENT

1 INTRODUCTION	3
2 STORING AND HANDLING	3
3 MATERIAL PREPARATION	5
3.1 Cleaning	5
3.2 Drying	6
3.3 Dimensional Change	7
3.4 Thermal Linear Change	7
3.5 Dimensional Change effected by Moisture Content	8
3.6 Flatness	8
4 SURFACE TREATMENT	9
4.1 Printing	9
4.2 Laminating	10
5 MACHINING	10
5.1 General Recommendations	10
5.2 Sawing	11
5.3 Drilling	12
5.4 Thread Cutting	13
5.5 Milling	13
5.6 Laser Cutting	14
5.7 Water Jet Cutting	14
5.8 Polishing	15
6 JOINTING	16
6.1 Bonding	16
6.2 Welding	18

INSTRUCTION OPTIONS

7 FORMING.....	19
7.1 Hot Bending.....	19
7.2 Thermoforming	20
7.3 Tempering	22
8 GLAZING	23
8.1 Vertical and horizontal glazing	24
8.2 Barrel Vaults	25
8.3 Thermal Insulation.....	26
9 CLOSING REMARKS.....	28

INSTRUCTION OPTIONS

1 INTRODUCTION

The manufacture of plastic articles from CRYLON[®] sheets normally involves secondary fabrication operations, including sawing, drilling, bending, decorating, and assembling.

This guide covers the properties and characteristics of CRYLON[®] that need to be taken into account if secondary operations are to be performed successfully.

2 STORING AND HANDLING

The originally packed plastic sheets should neither be stored outside nor be exposed to great variations of weather and/or temperature.

When storing under conditions with substantial variation of temperature and humidity, flat shape distortion (corrugation) of the sheet can happen, even when stored flat and stacked.

Polyethylene film protects sheets against dirt, mechanical load and scratches. It is recommended to leave the protective PE film in place until final processing.

Our standard PE protective film (without glue) is not designed for long-term open-air exposure/protection - it has only moderate UV- and heat-resistance.

If sheet is stored outside, without protection, the protective foil should be removed four weeks after film application latest, as there is a risk of brittleness and difficult removal of the degraded PE film. This could lead to the damage of the sheet surface.

If sheet is stored inside under normal stable storage conditions, it is recommended to remove the film 6 months after film application latest.

The special products CRYLON[®] soft tone are masked with special films. Details regarding suitability and processing properties can be taken from the referring technical data sheets, which can be obtained from technical customer service.

INSTRUCTION OPTIONS

CRYLON[®] standard products could be protected with self-adhesive foil on demand.

It has to be considered that there is always a risk that the film could be difficult to remove and leave glue residues on the sheet surface after removal depending on storage conditions.

Polycasa is unable to give a recommendation in how long time the sheet can be safely stored with self-adhesive film.

Customers are recommended to carry out own trials.

Polycasa cannot take any responsibility for problems caused by self-adhesive film.

Depending on storage and climatic conditions, plastic sheets absorb moisture.

Although humidity absorption has no practical influence on the physical properties, it may interfere during further processing of the sheets at higher temperatures e.g. during bending, or heating before thermoforming.

Therefore, according to the intended use, the sheets may have to be pre-dried (see 3.2. Drying).

Differences in temperature and moisture-content between top- and bottom-side of sheet or between different sheet areas can cause different dimension changes inside the sheet.

This can result in waviness of the sheet after a short time.

It is recommended to store the sheet under constant temperature- and humidity-conditions on a flat surface.

INSTRUCTION OPTIONS

3 MATERIAL PREPARATION

3.1 Cleaning

Protection film removal will induce a build-up of the electrostatic charge on the sheet surface. This electrostatic charge attracts airborne dust, and other fine particles.

Therefore, prior to further processing, it is recommended to clean the sheet by antistatic treatment (e.g. blowing by ionized compressed air or cleaning by hand with a cloth wetted with suitable antistatic agents).

This is particularly important prior to thermoforming process, as dust and other fine particles will cause imprints on the molded surface.

Plain water will suffice for both cleaning and care of the sheets.

In case of excessive dirt, clean with warm water and a weakly alkaline, non-abrasive cleaning agent.

The sheets should be dried with a soft cloth or with chamois leather. Dry scrubbing of the surface will cause scratches and possible damage. Microfiber wipers are not recommended.

Very greasy and oily surfaces should be cleansed with aromatic -free benzine or petroleum ether.

Other chemicals suitable for cleaning CRYLON[®] sheets:

- Diluted acids such as citric acid, hydrochloric acid, sulphuric acid
- Diluted caustic soda or caustic potash solution
- Common vinegar
- White spirit, neutral soap and household detergents

Removal of spray paints (graffiti) is only possible to a limited extent. A water-soluble brush cleaner or white spirit can be used.

The cleaning agent may only be applied for a short time (max. 5 min.) and must then be rinsed immediately with clear water.

Fogging can occur in the material. Polishing with polishing pastes is possible.

INSTRUCTION OPTIONS

3.2 Drying

As with most plastics, CRYLON[®] sheets absorb moisture during storage.

Whilst processing at higher temperatures, this can produce bubbles; therefore, pre-drying below softening point temperature is advisable.

Normally pre-drying of sheets with high moisture contents in an oven with air circulation, 24 hours at 80°C for CRYLON[®] and 24 hours at 75°C for CRYLON[®] High Impact, will suffice.

To achieve good drying results, air circulation between the sheets must be ensured; the protection foil must be removed before drying.

CRYLON[®] sheets must be cooled down slowly to avoid repeated induction of moisture or internal stress due to cooling down too fast after drying.

The maximum cooling speed after drying has to be less than 15°C per hour; the maximum oven temperature from which the sheet may be removed is 60°C.

In most cases, pre-drying can be avoided before hot folding.

In general, CRYLON[®] sheets need not be pre-dried prior to thermoforming, provided that the material has been adequately stored and the foil is undamaged.

To minimize costs, the drying heat should be exploited by immediate follow-on forming after the drying process.

Preliminary tests are recommended.

INSTRUCTION OPTIONS

3.3 Dimensional Change

There are substantial orientation forces involved in the extrusion process to form the sheet from the molten polymer. A part of these forces remains “frozen” in the sheet.

When the sheet is to be heated e.g. before thermoforming, this stress became apparent in shrinkage of the sheet. The shrinkage is always higher in parallel to the extrusion direction. Longitudinal shrinkage is always higher in thin sheets and lower in thick sheets. Such dimensional change has to be taken into consideration when cutting sheets to be thermoformed. When the material is heated and fixed in a clamping frame, no material shrinkage will arise. As the shrinkage value depends on both heating temperature and heating time, preliminary tests are advisable.

Maximum longitudinal shrinkage values of CRYLON® comply with ISO 7823-2:

Sheet thickness	Amount of shrinkage
1.50 mm up to <2 mm	≤15%
2.00 mm up to <3 mm	≤12%
3.00 mm up to 25 mm	≤7%

3.4 Thermal Linear Change

Like nearly all materials, CRYLON® is subject to linear change at variable temperatures. Plastics show higher linear change than metals, and this must be taken into account when mounting CRYLON® sheets into frames.

CRYLON® sheets show a coefficient of linear thermal expansion as follows:

Material	α [mm/m x $\Delta^\circ\text{C}$]
CRYLON®	0.07
CRYLON® HI 630	0.09
CRYLON® HI 620	0.10
CRYLON® HI 610	0.11

When mounting CRYLON® sheets, attention must be paid to the elongation clearance in order to avoid damage during material usage. For more technical data - see chapter „8 Glazing“.

INSTRUCTION OPTIONS

3.5 Dimensional change effected by moisture content

CRYLON[®] absorbs moisture during storage and application.

Beyond the thermal linear change, the content of moisture can effect an additional dimensional change up to 0.5%.

When mounting CRYLON[®] sheets, attention must be paid to the elongation clearance in order to avoid damage during material usage.

Variation and differences in moisture content between interior and outside surface of a sheet (e.g. swimming-pool glazing, terrarium, greenhouse, winter garden, multiple glazing) effect different elongation between the sheet surfaces.

This difference can cause curvature of the mounted sheet.

This curvature can be avoided by choosing an applicable higher thickness of sheet, in order to get inherent stability.

Preliminary tests are recommended.

3.6 Flatness

With increasing thickness extruded CRYLON[®] sheets can show a slight deviation in flatness due to the cooling behavior of the material.

Flatness is determined on a cut-to-size sample 1000 x 1000 mm.

Thickness	Planarity
≤ 10 mm	≤ 2 mm
> 10 mm	≤ 3 mm

INSTRUCTION OPTIONS

4 SURFACE TREATMENT

4.1 Printing

Silk-screen printing is the most commonly used method for printing CRYLON® and allows the creation of a wide range of graphics.

Distortion screen printing allows the flat sheet to be formed after printing into a three dimensional article with correct print register. Allowance must be made for “stretching” of the image when designing the graphics.

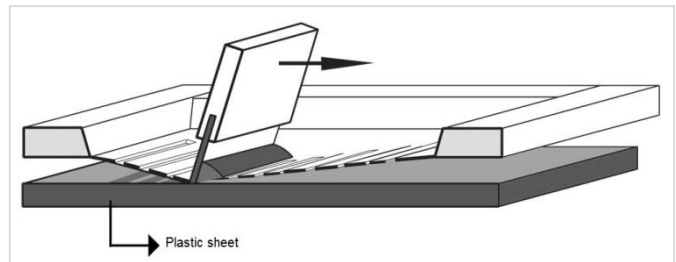

For the thermoforming of printed sheets, heating systems should be used which ensure uniform temperature control of the plate surface. Halogen spotlight systems should not be used.

During the **silk-screen print process**, the high-viscous ink is pushed through a photo chemically pre-treated screen print fabric (polyamide or polyester) by mechanical action or by means of a hand-operated scraper. The ink is transferred to the sheet beneath the screen fabric.

UV digital printing is another way of printing. In order to obtain a uniform print image, good color spread and adhesion, the surface tension of substrate and printing ink should be adjusted. We recommend contacting the hardware and/or ink supplier and, if necessary, carrying out tests.

Spray painting is another popular method. For the production of multi-colored workpieces, stencils or masking lacquers has to be used.

In order to avoid stress cracking of CRYLON®, only acrylic compatible inks must be used. Where necessary the sheets has to be tempered after machining or forming processes, pre-dried or cleaned before application of ink, to avoid stress cracks and adhesion problems.

INSTRUCTION OPTIONS

4.2 Laminating

The application of decorating foils or self-adhesive lettering or transfers is only suitable for flat or slightly curved sheets. Care should be taken that adhesive foils are used which not produce stress cracking of CRYLON[®] sheets.

Evaporation may cause partial separation of the self-adhesive film; therefore CRYLON[®] sheets should be pre-dried overnight at a temperature of 70 - 80°C.

Impurities such as dust particles can also lead to partial foil removal, which will impair the appearance of the lamination.

Where necessary the sheet has to be tempered or cleaned before application of adhesive film, to avoid stress cracks and adhesion problems.

5 MACHINING

5.1 General Recommendations

CRYLON[®] sheets can be worked with most tools used for metals.

Both cutting speed and forward feed should be such that the material doesn't melt.

In order to avoid smearing of the material, as little heat as possible should be generated during the machining process.

A well sharpened tool, with the necessary tool angles for CRYLON[®], is a basic requirement.

In addition, heat can be dissipated by cooling the tool, which with CRYLON[®] can only be done with water or acrylic glass compatible drilling emulsions.

The cooling reduces the local heating of the processing area and the resulting post-processing stresses.

INSTRUCTION OPTIONS

5.2 Sawing

Circular saws, band saws and jig saws can easily be used to work CRYLON®.

The use of new and well sharpened tools is recommended.

When using circular saws, blades with tungsten carbide-tipped cutting edges have proven effective.

At very high cutting speeds and cut-off frequency respectively, the saw blade should be cooled by compressed air, water spray or using an adequate cooling emulsion.

It is very important to employ an efficient saw dust extraction system to remove saw dust and chips generated by the saw blade.

Band saws are frequently used to trim the mouldings. The cut edge remains quite “rough” due to the slightly “crossed” saw teeth.

Jigsaws can cut out recess clearances. The cut edge often turns out to be rough. Only saw blades should be used which are suitable for acrylic treatment.

When working with jigsaws, the shoe of the jigsaw must be tightly pressed to the surface of the sheet and a high cutting speed should be selected.

The rotary stroke should be switched off, especially when using thin sheets.

The sheets must be adequately fixed to avoid saw chattering or vibrating.

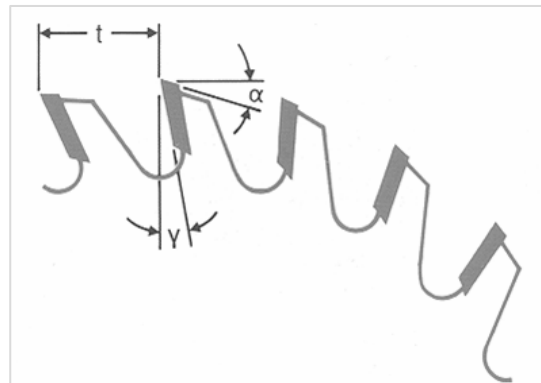

Sawing recommendations:

Band saw/circular saw machining	Band saw	Circular saw	Jigsaw
Clearance angle α	30-40°	15-20°	Commercially available saw blades suitable for acrylic
Rake angle γ	0-8°	0-5°	
Cutting speed	1000-3000m/min.	3000 m/min.	
Circular pitch t	3-8 mm	10-20 mm	

INSTRUCTION OPTIONS

5.3 Drilling

Commercial quality twist drills for metal can be used. The point angle should be adapted to about 60°-90°.

Best drilling capacity is achieved with a cutting speed of 25-80 m/min and a feed rate of 0.1-0.2 mm p.r.

Excessive feed rate will cause brittle fracture of material; low feed rate at high cutting speed will lead to material overheating.

Material thickness beyond 5 mm will require cooling and lubrication with acrylic compatible drilling emulsion or bore oil.

Deep-hole boring requires frequent airing of the drill in order to prevent local overheating.

When drilling thin sheets, it is advisable to fix them on a solid, flat support to avoid brittle breaks of the lower edge of the drilled hole.

Drilling of CRYLON[®]

Clearance angle α	3 - 8°
Twist angle β	12 - 16°
Point angle ϵ	60 - 90°
Rake angle γ	0 - 4°
Cutting speed (m/min)	25 - 80

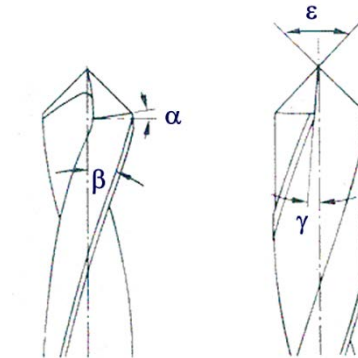

INSTRUCTION OPTIONS

5.4 Thread Cutting

Internal thread cutting in CRYLON[®] sheets is feasible with commercially available taps. Tools producing threads with slightly rounded core diameters are particularly suitable. Compared to steel, the core drilling clearance should be about 0.1 mm larger.

Thread cutting requires frequent chip discharge with compressed air. Only cooling lubricants compatible with acrylic should be used.

Follow-on screw fitting implies that the metal screws employed are oil film-free or protected against corrosion by means of oil compatible with acrylic.

Compared to cast acrylic' extruded acrylic shows an increased breakage risk by notch effect. Fixings which are frequently removed should be provided with threaded inserts. Screw connections with through-holes, clamps or gluing are preferable.

5.5 Milling

Universal, profile, spindle moulding and hand milling cutters at cutting speeds up to 4500 m/min can be used for milling CRYLON[®] sheets.

Small tool diameters require the application of one or two-edged milling cutters. They offer perfect removal of chips, high cutting speed and an excellent milling pattern.

When using one-edged milling cutters, the clamping chuck must be carefully tightened to avoid component marks on the sheet.

Cooling is not always required when milling CRYLON[®] sheets with one or two-edged end mills, as they produce less heat than multi-edged end mills.

INSTRUCTION OPTIONS

5.6 Laser Cutting

CRYLON[®] sheets are easy to cut with a CO₂- laser.

Brilliant edges of cut can be achieved but this can vary depending on type, thickness and surface treatment. The laser operating efficiency should amount to 300 – 1000W. Inert gas rinsing and extraction of monomer vapors must be ensured.

Preliminary tests are essential in order to determine exact positioning in each case.

Inclined edges of cut, not being square to the sheet surface, will result from increasing material thicknesses. Neodym-YAG lasers permit excellent engraving of colored CRYLON[®] sheets.

High thermal load in the cut edge zone generates stresses liable to produce stress cracking when being in contact with corrosive substances (during bonding process for example). Tempering of components will prevent cracking by stress relief at a temperature of 80°C (see chapter 7.3 „Tempering“).

During laser cutting, the cut edges of CRYLON[®] High Impact grades do not show the same brilliancy as CRYLON[®] grades; the edges of cut can be somewhat “tacky”.

5.7 Water Jet Cutting

Similarly to laser cutting, the possible cutting speed depends on both thicknesses of the material to be cut and desired cutting quality.

Unlike laser cutting, the cut edges look “sand-blasted” as a result of water jet cutting.

No thermal stresses occur in the material when using water jet cutting technique.

The water used for cutting CRYLON[®] sheets contains abrasive additives. Good results are achieved with a cutting speed of 1500 - 2000 mm/min and a material thickness of 4 mm.

A feed rate of 400 - 800 mm/min and a material thickness of 10 mm will produce good results.

INSTRUCTION OPTIONS

5.8 Polishing

Prior to hand-operated polishing, the sheet must be ground. Hand-operated grinding requires the use of 80-600-grit abrasive paper as well as several grinding work cycles from rough-grind up to finish-grind.

Mechanical grinding should be done with belt grinders and a belt speed of 5 - 10 m/s. High surface temperatures can be avoided by lightly pressing on the work piece.

Polishing is made with buffing or fleece polishing wheels, polishing felts and adequate polishing wax.

Polish-milling with diamond-tipped tools is another process option. The surface quality is such that no further treatment is required. Polish-milling - in one single work cycle without rough-grinding – will produce excellent finish.

No internal stress occurrence; tempering which is essential to other procedures, becomes redundant.

Flame-polishing of CRYLON® does not require additional grinding work cycles. The edges to be polished must be sawdust free and oil free. Sawing and milling lines may still be visible - even after polishing.

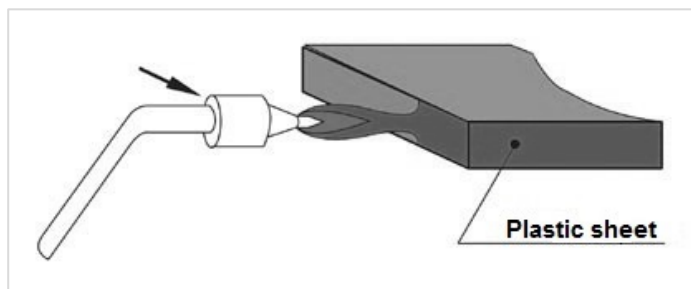

Improved surface finish is achieved by treating the sawn edge with an iron scraper prior to flame polishing.

Due to pigments, colored material often shows matt edges.

Flame polishing is not recommended for sheets with a thickness of more than 10 mm because of local overheating and resultant stresses.

If followed by contact with corrosive substances such as solvents, glues or inappropriate cleaning agents, tempering will be essential.

INSTRUCTION OPTIONS

6 JOINTING

6.1 Bonding

The joint faces must be cleaned prior to bonding. Use warm water containing some washing-up liquid, if necessary.

Dry with an absorbent, lint free fabric (e.g. glove material). Highly greasy or oily surfaces can be washed with cleansing petrol.

The components to be bonded should be tempered to release stresses prior to bonding in order to avoid potential stress cracking (crazing) due to the reaction with the solvent glue.

This applies especially to components having been machined by metal-cutting tools or cut by laser.

Solvent adhesives are particularly suitable for small and plane bonding surfaces.

As the solid content of such glues is low, they have no joint filling capability. When bonding the sawn edge, smoothing the surface to be bonded using sharp edge scraper can reduce possible bubble formation.

Immersion technique implies that the edge to be glued is dipped into solvent or solvent adhesive, which is poured approx. 1 mm high onto a glass or PE sheet; the parts are afterwards firmly jointed.

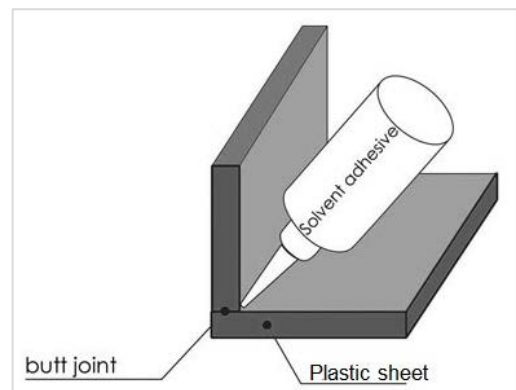

Capillary method offers a simple technique for jointing and fixing of the parts.

Solvent adhesive/solvent, is applied onto the bonding surface by means of a PE-vial and is soaked into the glued seam due to the capillary effect. A few seconds later, the joint should be firmly pressed together with 1g/mm^2 to set the joint.

INSTRUCTION OPTIONS

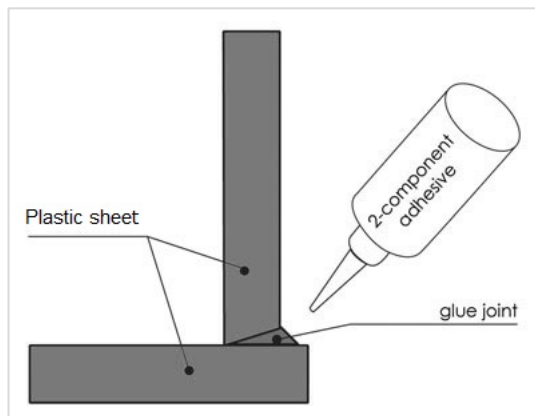

Polymerization adhesives are also suitable for large and uneven bonding surfaces. Planar bonding is possible.

The pasted seam must be prepared by chamfering; this does not apply to butt joint bonding.

The adjacent sheet area must be masked with an adhesive compatible tape.

The adhesive must be mixed as prescribed by the adhesive supplier.

Removal of bubbles in vacuum is possible.

The adhesive must be applied bubble-free by means of a PE-vial or a disposable syringe. Excess adhesive must be provided, as the polymerization adhesive exhibits volume shrinkage during curing.

Silicones are often used to seal glazing. For this purpose, only silicones compatible with acrylic must be employed.

Silicone sealants as found in DIY centers, give off substances during curing which will result in stress cracks of the glued components.

Our technical service department will provide you with information on appropriate products.

INSTRUCTION OPTIONS

6.2 Welding

Hot-gas welding is the most frequent welding technique used for CRYLON® sheets.

The strong heating of the weld zone and the cooling effect from the adjacent sheet surface areas result in tensile stress formation after cooling. This must be relieved by tempering, as they will lead to stress cracking when in contact with solvent and adhesives.

Quadratic sheet strips of CRYLON®, round rods or sheet strips of PVC rigid will serve as filler material.

Gas-welding temperature should amount to 280 - 350°C.

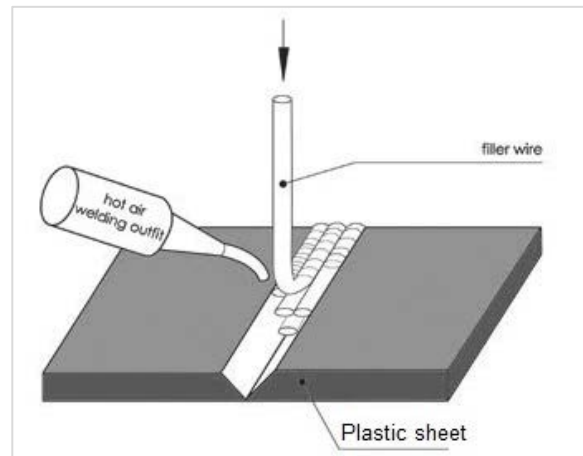

More technical data

Welding pressure / 3 mm rod	20 Newton
Welding speed	150 to 250 mm/min
Distance from nozzle to welded joint	10 to 20 mm
Air mass	about 25 l/min

The die diameter should be more or less the same as the filler rod diameter.

INSTRUCTION OPTIONS

7 FORMING

NOTE: Prior to thermoforming and hot bending of CRYLON[®], it is recommended to remove the protective foil.

As the foil behavior depends on material processing conditions such as draw ratio and required temperatures, simple moldings can be formed without removing the foil.

Preliminary tests are essential to determine the foil behavior in each individual case.

7.1 Hot Folding

Hot bending technique means extended heating of the sheets followed by bending and fixing until the sheets have cooled down.

Extended heating is carried out by filaments or heating rods. The heating time depends on the equipment employed and will rise considerably according to increased material thickness.

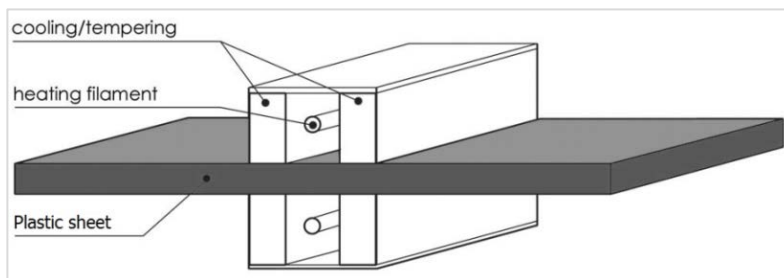

It must be possible to bend the material under low strain in order to avoid strong stresses in the material. The bend radius must be twice as big as the material thickness in order to prevent wrinkles and high stresses.

Visual appearance of the inner bend can be improved by using the biggest possible bend radii and thin sheets.

The heating width should be at least 3 to 5 times larger than the sheet thickness. A heating width of 3 times the sheet thickness is adequate for small bend radii.

Too small heating zones will lead to excessive elongation and straining in the bend area and - as a result - to optical impairment. Large heating widths will enable production of big bend radii.

Due to the memory effect, the exact angle specifications must be determined by preliminary tests.

INSTRUCTION OPTIONS

7.2 Thermoforming

Thermoforming technique means that, at increased temperatures, thermoplastic semi-finished products are shaped into three dimensional plastics moldings. The sheet material is heated up to the thermo-elastic temperature range and shaped by suitable molds.

Vacuum forming requires a forming temperature of 160 - 190°C. Good results are realized with a mold temperature of 85°C.

Venting bores in vacuum molds should have a diameter of \varnothing 0.8 mm.

Too large diameters will cause marks.

Processing shrinkage of CRYLON[®] will amount to 0.5 - 0.8% depending on the procedures employed.

Lower forming temperatures will suffice to form CRYLON[®] HI grades, the impact modified CRYLON[®] sheets.

A forming temperature of 140 - 170°C is sufficient when forming CRYLON[®] HI 610.

The forming temperatures necessary to form high impact grades HI 620 and HI 630 are between those required for CRYLON[®] HI 610 and CRYLON[®].

At a temperature beyond 80°C, CRYLON[®] HI 610/620/630 grades will show a distinct turbidity that will recede during cooling process.

Should bubbles appear when heating CRYLON[®], this is due to moisture absorption during storage; in that case, the sheets must be pre-dried before forming.

In general, overnight pre-drying at 80°C will suffice (see chapter 3.2. "Drying").

INSTRUCTION OPTIONS

Positive and negative forming

Dependent on whether the inside or the exterior of the moldings contact the tool, the techniques are called “positive” or “negative” forming. Positive forming means that the heated semi-finished product is pulled over the mold.

This is also known as “male” forming. In doing so, some surface areas of the heated semi-finished products may excessively cool down, so that complete drawing is not feasible and “thick spots” will occur.

Some typical problems during positive forming, such as wrinkle or web formation (2) and shock marks, can be solved by adequate pneumatic stretching prior to final “pull down. High tool temperatures and high tool speed can also cause shock marks.

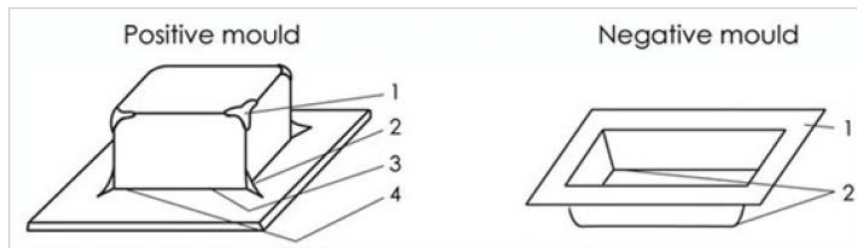

Negative forming means that the semi-finished sheet is drawn into the mold cavity. This is sometimes called “female” forming.

Thin corner areas (2), which may appear during negative forming of sharp-edged components, can be reduced by mechanical top die stretching.

Procedure variant

Dome-shaped mouldings can be thermoformed without a mould. This method produces mouldings of good surface quality showing no optical defects.

The dome form is determined by the clamping frame’s shape and the dome height by the blown air pressure.

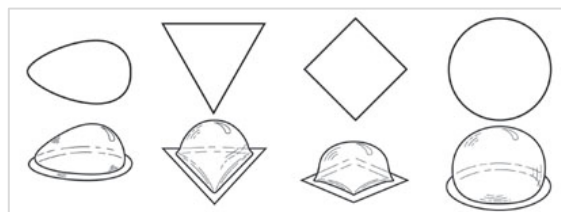

INSTRUCTION OPTIONS

7.3 Tempering

CRYLON® is able to take up rather high tensile stresses, but only if corrosive substances do not simultaneously act upon the materials.

Tensile stresses are induced by machining, laser-cutting, thermoforming, varying heating and external stresses, for instance. Tensile stresses expand the material structure thus reducing the resistance to environmental conditions.

The effect of printing ink solvents, monomer vapors, sealing and foil plasticizers as well as inappropriate cleaning agents may result in crack formation.

Crack formation will be excluded by stress free components. Therefore, generation of tensile stresses and contact with corrosive substances must be avoided.

As accidental contact with corrosives cannot be ruled out, tensile stresses must be avoided. Stress relief tempering of the parts can achieve reduction of internal stresses. External stresses must be excluded by using adequate fastening systems.

Tempering of CRYLON® should take place in heating cabinets with air circulation, at a temperature of 70 - 80°C.

It is recommended to temper without protection film.

Material thickness (mm)	1.5	2	2.5	3	4	5	6	8	10	12	15	18	20	25
Tempering duration (h)	2	2	2	2	2	2	3	3	4	4	5	6	7	8

CRYLON® sheets must be cooled down slowly to avoid repeated induction of the internal stress or moisture due to cooling down too fast after annealing.

The maximum cooling speed after annealing has to be less than 15 °C per hour.

The maximum oven temperature from which the material may be removed is 60°C.

INSTRUCTION OPTIONS

8 GLAZING

CRYLON® expands under heat and moisture absorption and contracts in cold and dry weather.

The linear change solely due to the change in temperature can be determined by calculating the coefficient of thermal expansion.

CRYLON® shows a coefficient of thermal expansion of 0.07 mm/(m x Δ°C)

(= 0.07mm length change per meter x °C temperature change)

The linear change must be allowed during the sheet's storage time. The maximum expected value of linear deformation depends on the temperature used when mounting the sheets.

An adequate free space of 5 mm/m should be kept with CRYLON® (guide value). The rebate should be approx. 20 – 25 mm deep.

To achieve impermeability of glazing to rain water, only sealing agents shall be used which are compatible with extruded acrylic sheet construction.

Sealing material must allow the movement of sheet inside the profiles due to dimensional changes of sheet. Profiled EPDM joints, preferably in white, have proven to be successful in heat loss avoidance. In most cases, profiled joints of non-rigid PVC and PUR foam are incompatible, due to the migration of plasticizers.

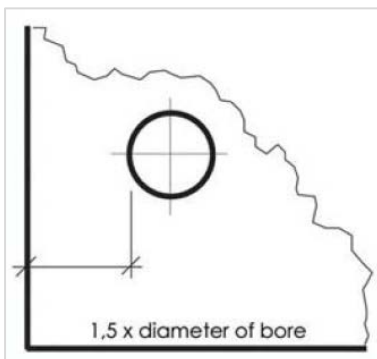
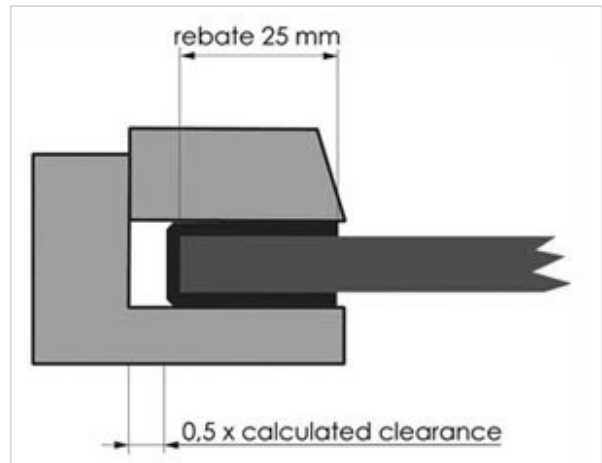

The drilled holes must be adequately dimensioned when fixing to specific points, in order to allow a sheet length clearance of 5mm/m, too.

In that case, sheet length is deemed to be the greatest existing distance between two holes.

To avoid material breaking at the sheet edge, a distance of 1.5 times the diameter of hole must be left.

INSTRUCTION OPTIONS

8.1 Vertical and horizontal glazing

The required material thickness for 4-side clamped glazing can specify according to the following table.

Material thicknesses needed for glazing primarily depend on the sheet size.

A surface load of 750 N/m² is taken as basis for the recommended material thickness in mm.

CRYLON [®] (material thickness)		Length (m)									
		0.5	1.0	1.5	2.0	2.5	3.0	3.5	4.0	4.5	5.0
Width (m)	0.5	3	4	4	4	4	4	4	4	4	4
	1.0	4	6	8	8	8	8	8	8	8	8
	1.5	4	8	10	10	12	12	12	12	12	12
	2.0	4	8	10	12	15	15				

Information on deviating surface loads or sizes is available from our application technology department upon request.

INSTRUCTION OPTIONS
8.2 Barrel Vaults

CRYLON® is suitable for cold bending technique.

This method facilitates the application of thinner material gauges compared to plane roofing, as an increased self-rigidity of the sheet is achieved due to the change in geometry. In order to exclude material damage caused by tension stress and environmental influences, **the min. bending radius must not be less than 330 x the sheet thickness.**

As far as fixing and sealing are concerned, only materials not having corrosive (crazing) effect on CRYLON® should be used.

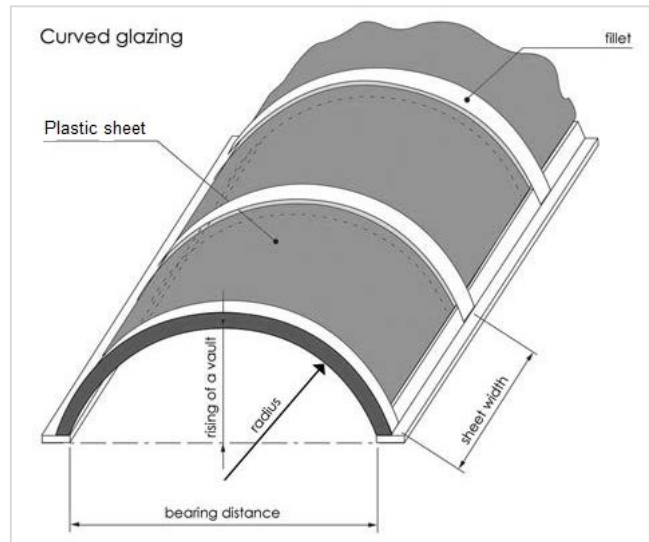

Recommended material thicknesses in mm at a given surface load of 750 N/m² can be obtained from the following table.

CRYLON®						
Fixing span (mm)		500	750	1000	1250	1500
	1000	3	3	3	3	
	1500	3	3	4	4	4
	2000	3	4	4	5	5
	2500	4	4	5	5	6
Radius r (mm)	3000	4	5	5	6	6
	3500	4	5	6	6	8
	4000	5	5	6	8	8
	4500	5	6	8	8	8
	5000	5	6	8	8	8

Information on recommended material thicknesses in case of various surface loads is available from our Technical Service Department upon request.

INSTRUCTION OPTIONS

8.3 Thermal Insulation

CRYLON® sheets when used for glazing represent considerable energy cost savings as they prevent excessive heat loss in winter and heat intrusion in summer.

The heat loss factor of CRYLON® normally referred to as U-value is significantly lower than for glass of the same thickness.

The U-value is the parameter which identifies the heat loss of a building with glazed walls.

Definition: The U-value (K-value) identifies the heat loss in watt per m² wall surface and per °C difference in ambient temperature of premises separated by the sheet.

The U-value depends on the glazing assembly.

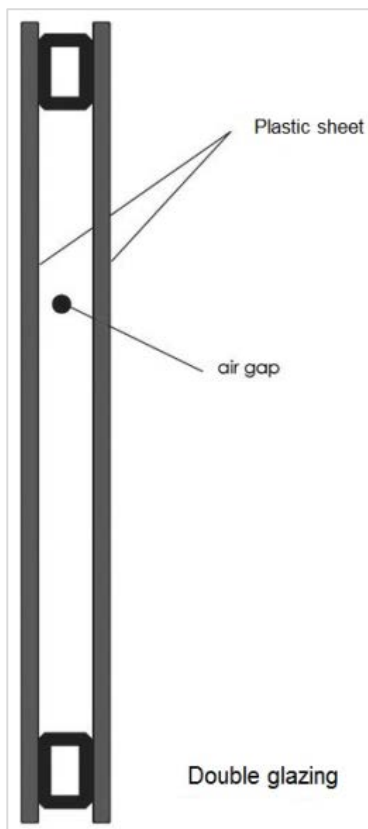

Examples of the thermal insulation power of CRYLON® in **single, double and triple glazing systems** are indicated below.

Compared to glass, they show significant advantages as to insulating effect and weight reduction.

INSTRUCTION OPTIONS

Installation		CRYLON®			Window glass	
Sheet thickness (mm)	Air gap (mm)	Composite strength (mm)	U-value (W/m ² *K)	Weight (kg/m ²)	U-value (W/m ² *K)	Weight (kg/m ²)
Single glazing						
2	-	2	5.54	2.38	5.83	4.96
3	-	3	5.39	3.57	5.80	7.44
4	-	4	5.24	4.76	5.77	9.92
5	-	5	5.10	5.95	5.74	12.40
6	-	6	4.96	7.14	5.71	14.88
8	-	8	4.72	9.52	5.66	19.84
10	-	10	4.49	11.90	5.60	24.80
Double glazing						
2	5	9	3.34		3.55	
2	10	14	2.94	4.76	3.10	0.92
2	15	19	2.77		2.91	
3	5	11	3.23		3.53	
3	10	16	2.85	7.14	3.09	14.88
3	15	21	2.69		2.90	
4	5	13	3.12		3.50	
4	10	18	2.77	9.52	3.07	19.84
4	15	23	2.62		2.88	
5	5	15	3.02		3.48	
5	10	20	2.69	11.90	3.05	24.80
5	15	25	2.55		2.87	
Triple glazing						
2	2 x 5	16	2.39		2.55	
2	2 x 10	26	2.00	7.14	2.11	14.88
2	2 x 15	36	1.84		1.94	
3	2 x 5	19	2.30		2.53	
3	2 x 10	29	1.94	10.71	2.10	22.32
3	2 x 15	39	1.79		1.93	
4	2 x 5	22	2.22		2.52	
4	2 x 10	32	1.88	14.28	2.09	29.76
4	2 x 15	42	1.74		1.92	
5	2 x 5	25	2.15		2.50	
5	2 x 10	35	1.83	17.85	2.08	37.20
5	2 x 15	45	1.70		1.91	

Information on further specific glazing systems can be obtained from our Technical Service Department upon request.

INSTRUCTION OPTIONS

9 CLOSING REMARKS

For more details on further processing methods, please contact our technical customer service.

Please note that our technical recommendations are without legal obligation.

The information given in this processing instructions is based on our current knowledge and experience.

It does not release the user from the obligation of carrying out own tests and trials, in view of the many factors that may affect processing and application.

A legally binding assurance of certain properties or suitability for a specific application cannot be derived from our information.

Any industrial property rights and existing laws and regulations must be observed by the recipient of our products on his own responsibility.

Technical data relating to our products are typical guide values and are subject to change without notice. The actual measured values are subject to minor production-related fluctuations.